

COOLUMA



Total Solution of Commercial Refrigerators

CATALOGS

CURVED GLASS TYPE

RA Series of Straight	03
RB Series of Straight	04
RC Series of Straight	05
RD Series of Straight	06
RE Series of Straight	07

STRAIGHT GLASS TYPE

CA Series of Curved	09
CB Series of Curved	10
CC Series of Curved	11
CD Series of Curved	12

FRONT OPEN TYPE

FA Series of Front Open	14
FB Series of Front Open	15

ARCH GLASS TYPE

AA Series of Arch	17
-------------------------	----

CORNER SECTOR TYPE

CA Series of Corner Sector	19
----------------------------------	----

CURVED GLASS TYPE

FLOOR STANDING CABINETS

>>>

Details and Benefits



01
Line Sense Landscaping



02
Condensate evaporation system

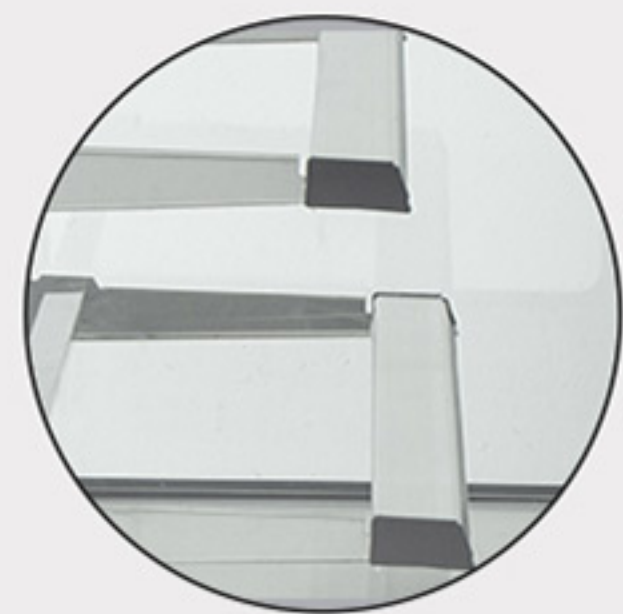

03
Stainless Steel Edged Shelf





RA SERIES OF STRAIGHT GLASS FLOOR STANDING CABINETS



RA900S3



RA900S2



R290 refrigerant



#201 Stainless Steel Base



Tempered electric heating film



CUBIGEL Press



Pixie Temperature Control

Model No	Temp Range(°C)	Dimension(mm)	Capacity(L)	Shelves
RA900S3	2-8	900×730×1300	480	3
RA1000S3	2-8	1000×730×1300	535	3
RA1200S3	2-8	1200×730×1300	650	3
RA1500S3	2-8	1500×730×1300	815	3
RA1800S3	2-8	1800×730×1300	985	3
RA2000S3	2-8	2000×730×1300	1100	3

Model No	Temp Range(°C)	Dimension(mm)	Capacity(L)	Shelves
RA900S2	2-8	900×730×1200	380	2
RA1000S2	2-8	1000×730×1200	425	2
RA1200S2	2-8	1200×730×1200	515	2
RA1500S2	2-8	1500×730×1200	650	2
RA1800S2	2-8	1800×730×1200	785	2
RA2000S2	2-8	2000×730×1200	875	2

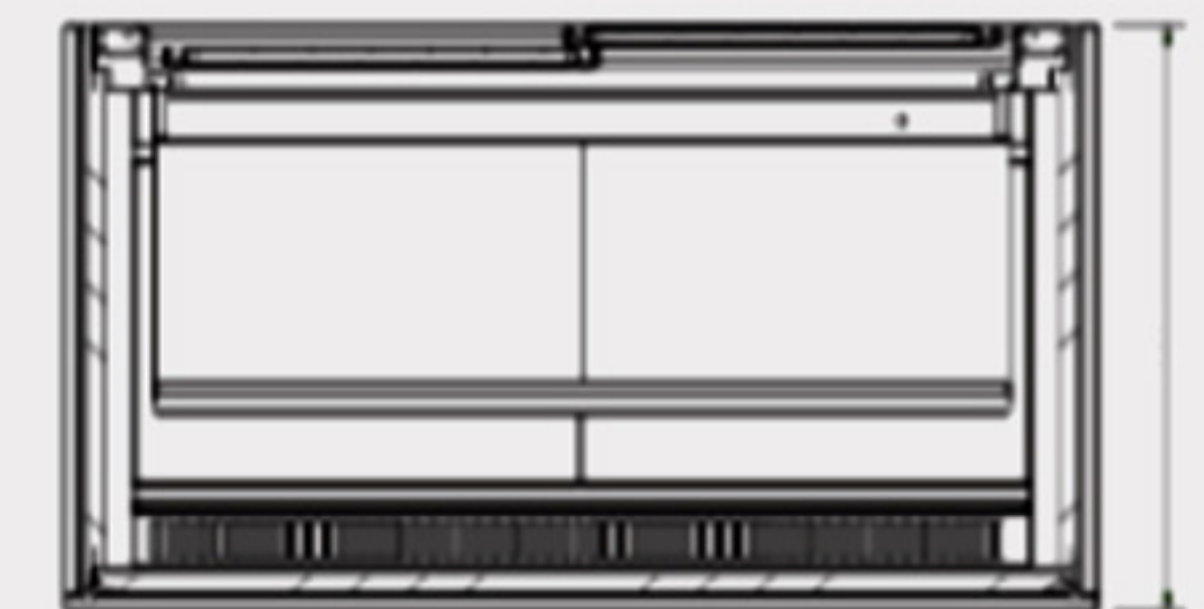
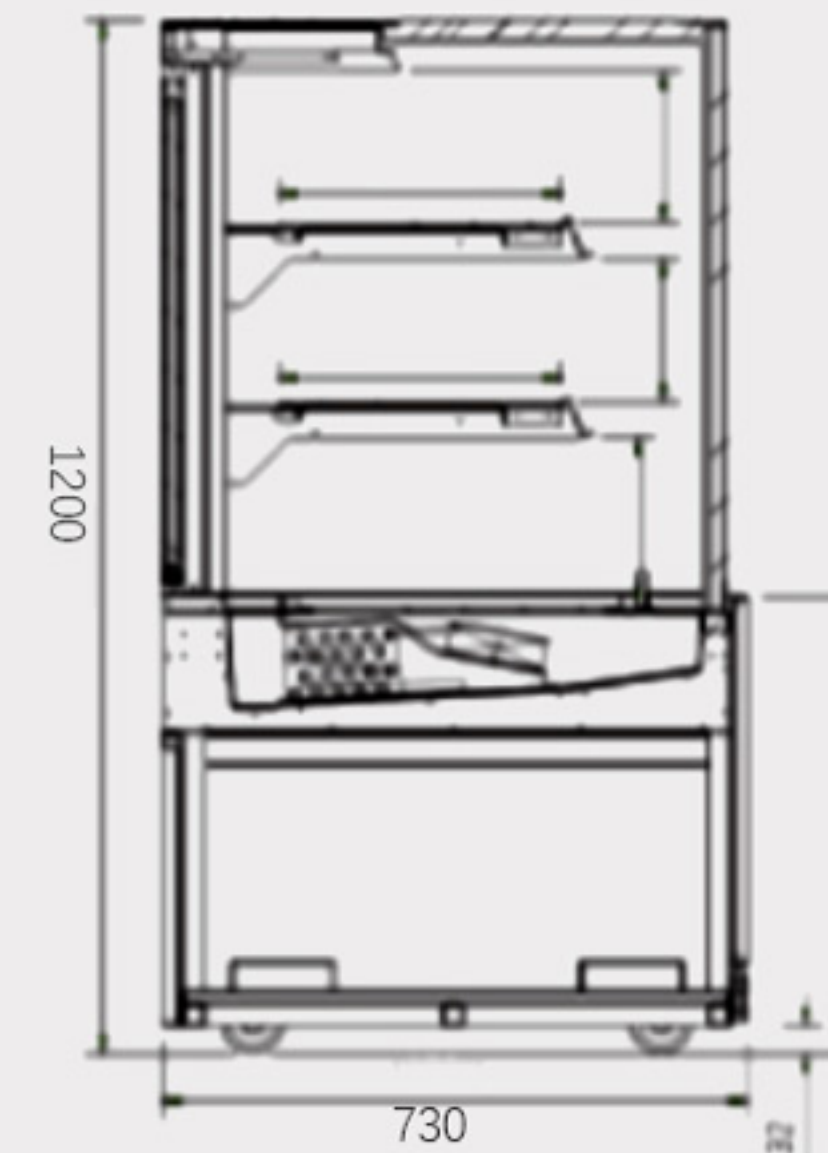
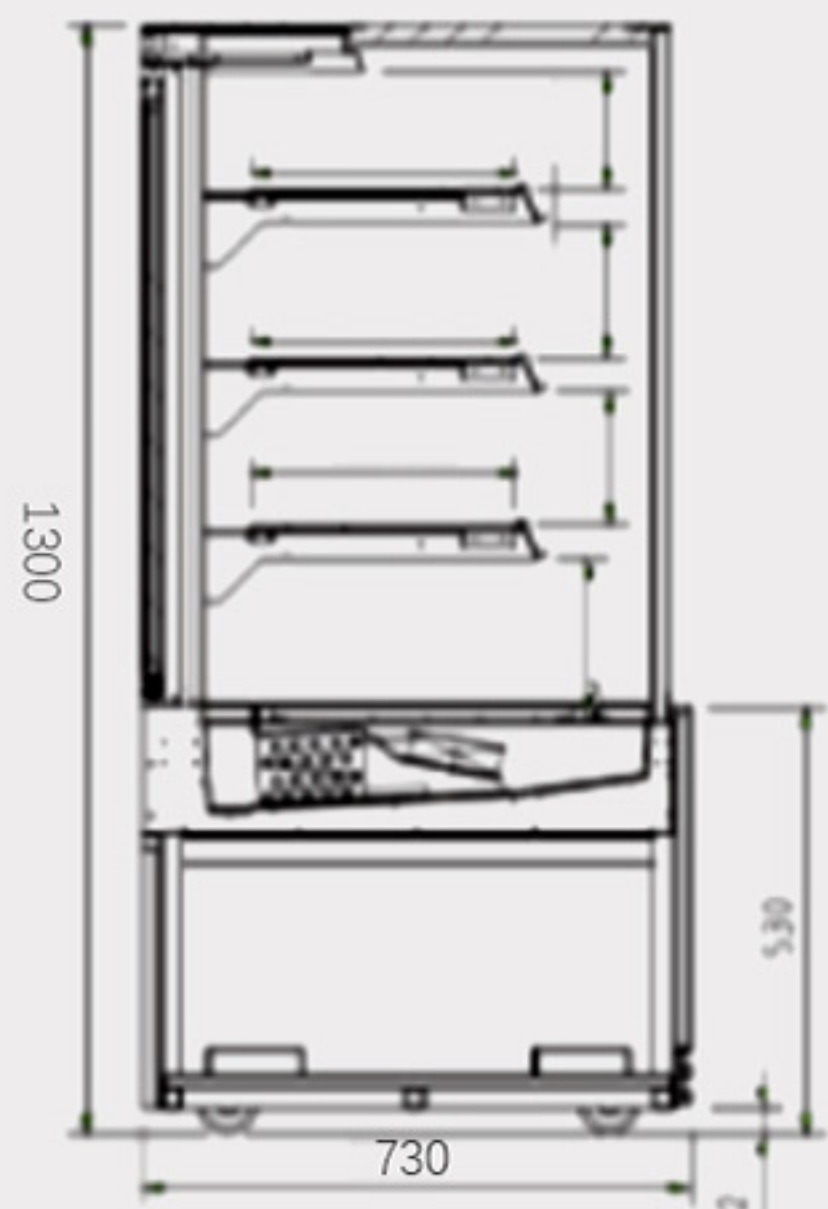



RB SERIES OF STRAIGHT GLASS FLOOR STANDING CABINETS



RB900S2



RB900S3



R290 refrigerant



#201 Stainless Steel Base



Side full glass



CUBIGEL Press



Pixie Temperature Control

Model No	Temp Range(°C)	Dimension(mm)	Capacity(L)	Shelves
RB900S3	2-8	900×730×1300	480	3
RB1000S3	2-8	1000×730×1300	535	3
RB1200S3	2-8	1200×730×1300	650	3
RB1500S3	2-8	1500×730×1300	815	3
RB1800S3	2-8	1800×730×1300	985	3
RB2000S3	2-8	2000×730×1300	1100	3

Model No	Temp Range(°C)	Dimension(mm)	Capacity(L)	Shelves
RB900S2	2-8	900×730×1200	380	2
RB1000S2	2-8	1000×730×1200	425	2
RB1200S2	2-8	1200×730×1200	515	2
RB1500S2	2-8	1500×730×1200	650	2
RB1800S2	2-8	1800×730×1200	785	2
RB2000S2	2-8	2000×730×1200	875	2

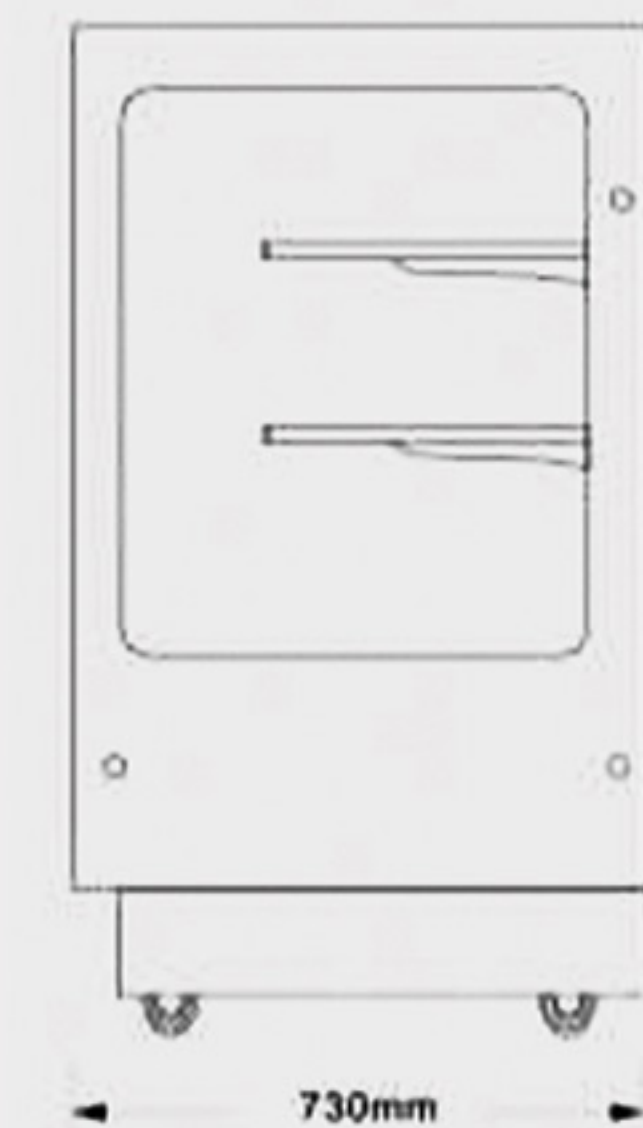
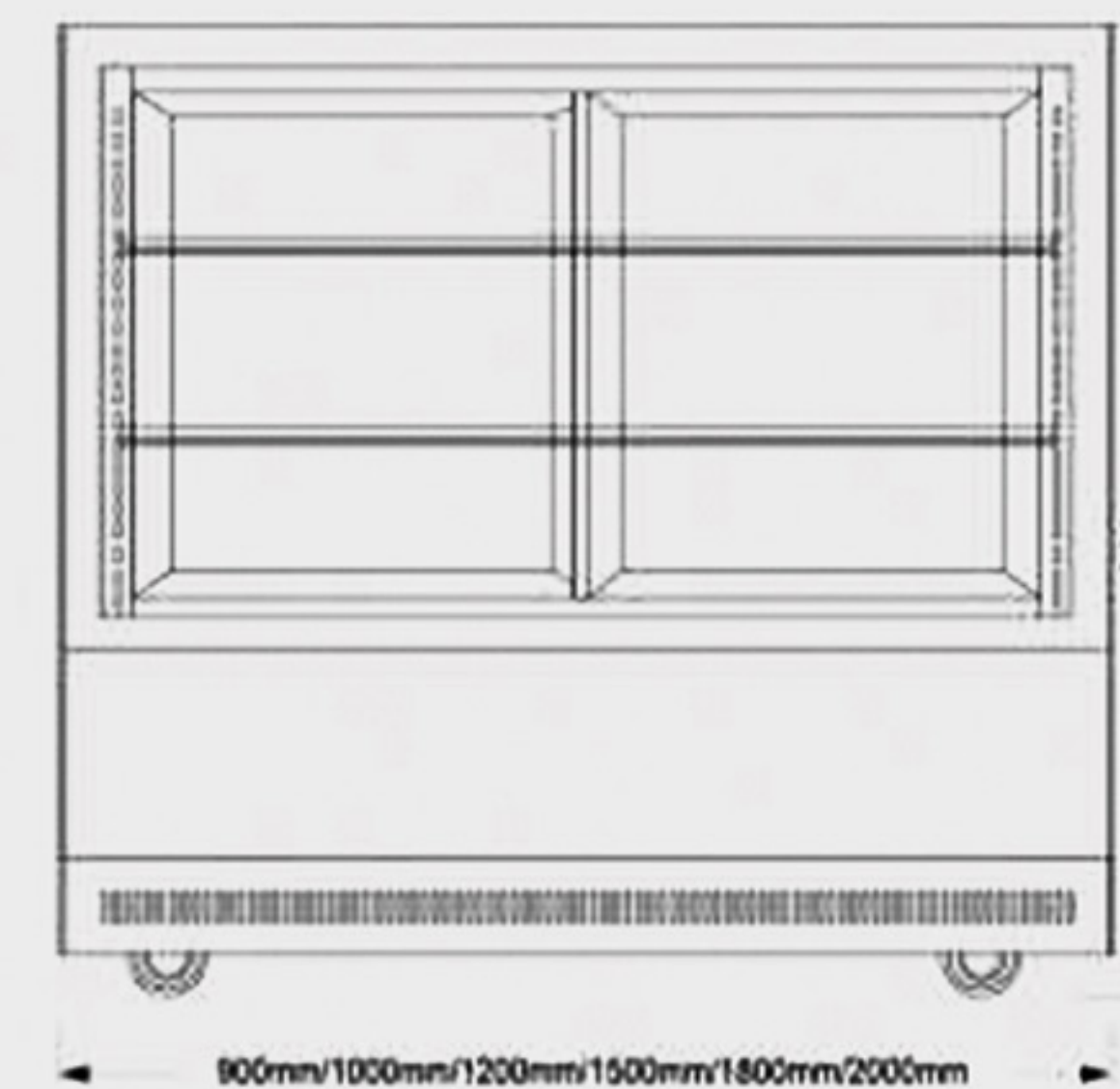
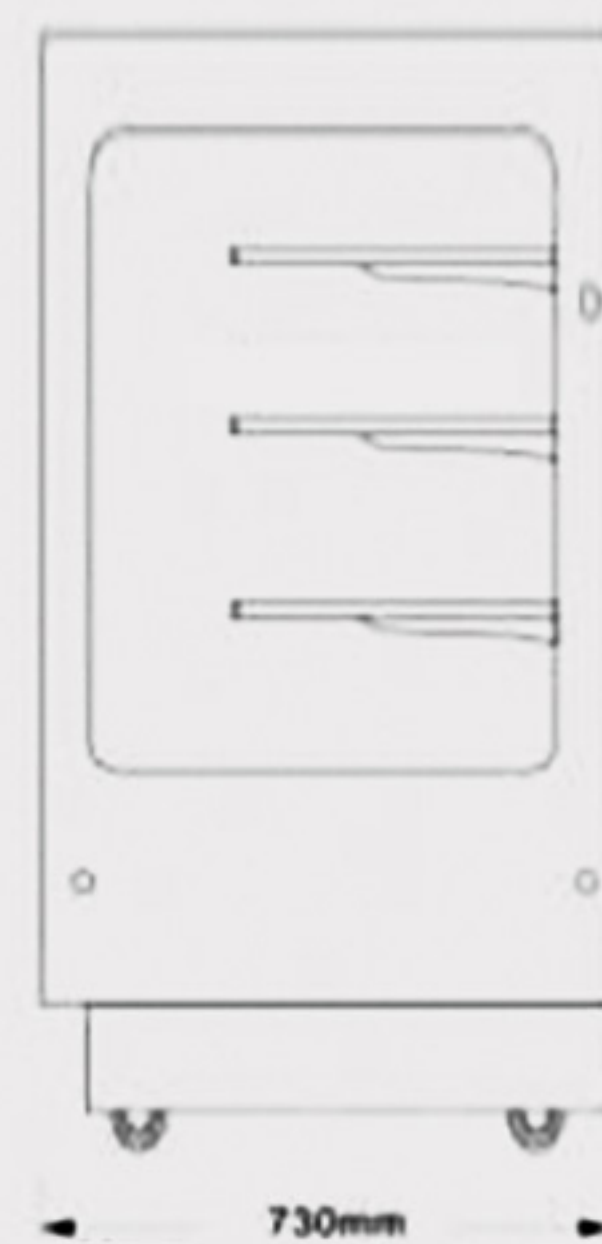
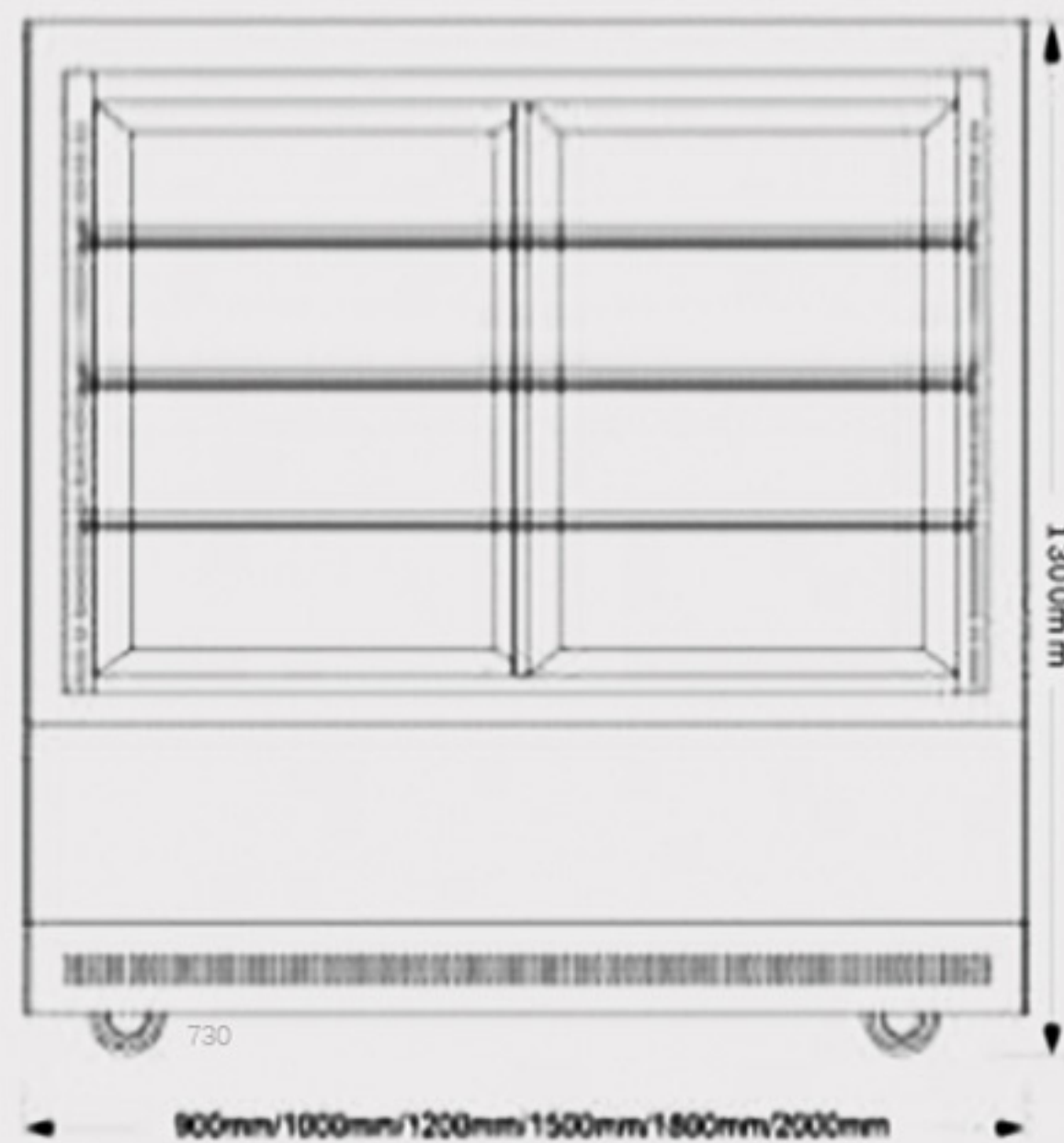



RC SERIES OF STRAIGHT GLASS FLOOR STANDING CABINETS



RC900S3



RC900S2



R290 refrigerant



#201 Stainless Steel Base



Tempered electric heating film



CUBIGEL Press



Pixie Temperature Control

Model No	Temp Range(°C)	Dimension(mm)	Capacity(L)	Shelves
RC900S3	2-8	900×730×1300	480	3
RC1000S3	2-8	1000×730×1300	535	3
RC1200S3	2-8	1200×730×1300	650	3
RC1500S3	2-8	1500×730×1300	815	3
RC1800S3	2-8	1800×730×1300	985	3
RC2000S3	2-8	2000×730×1300	1100	3

Model No	Temp Range(°C)	Dimension(mm)	Capacity(L)	Shelves
RC900S2	2-8	900×730×1200	380	2
RC1000S2	2-8	1000×730×1200	425	2
RC1200S2	2-8	1200×730×1200	515	2
RC1500S2	2-8	1500×730×1200	650	2
RC1800S2	2-8	1800×730×1200	785	2
RC2000S2	2-8	2000×730×1200	875	2

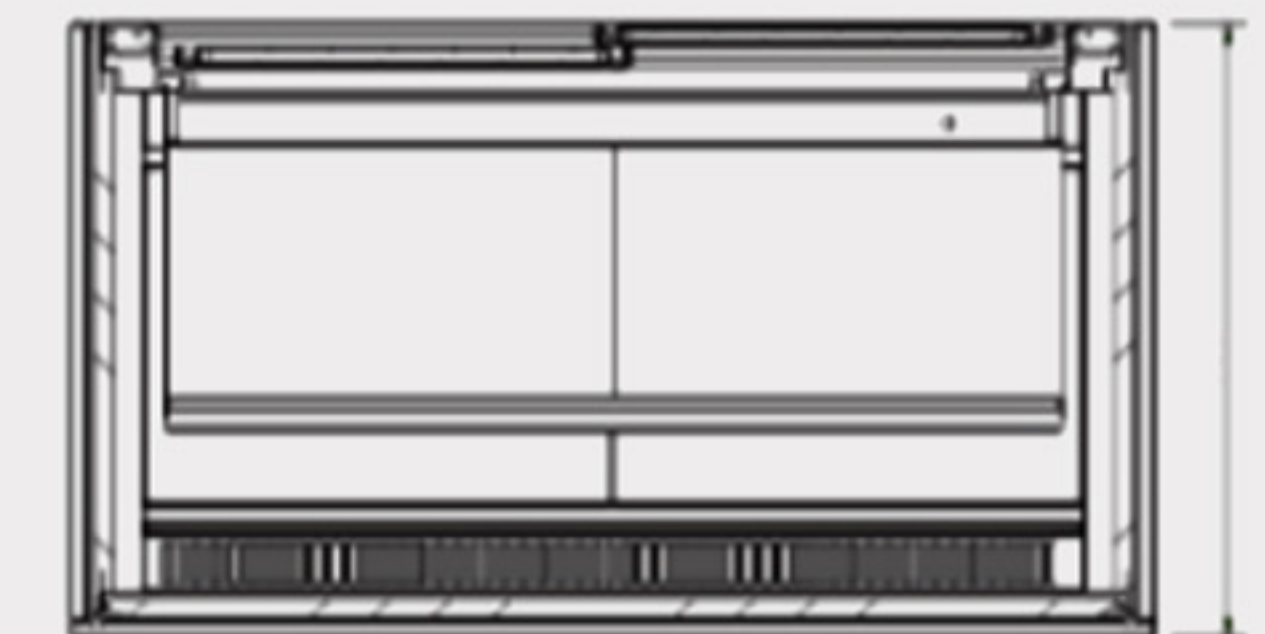
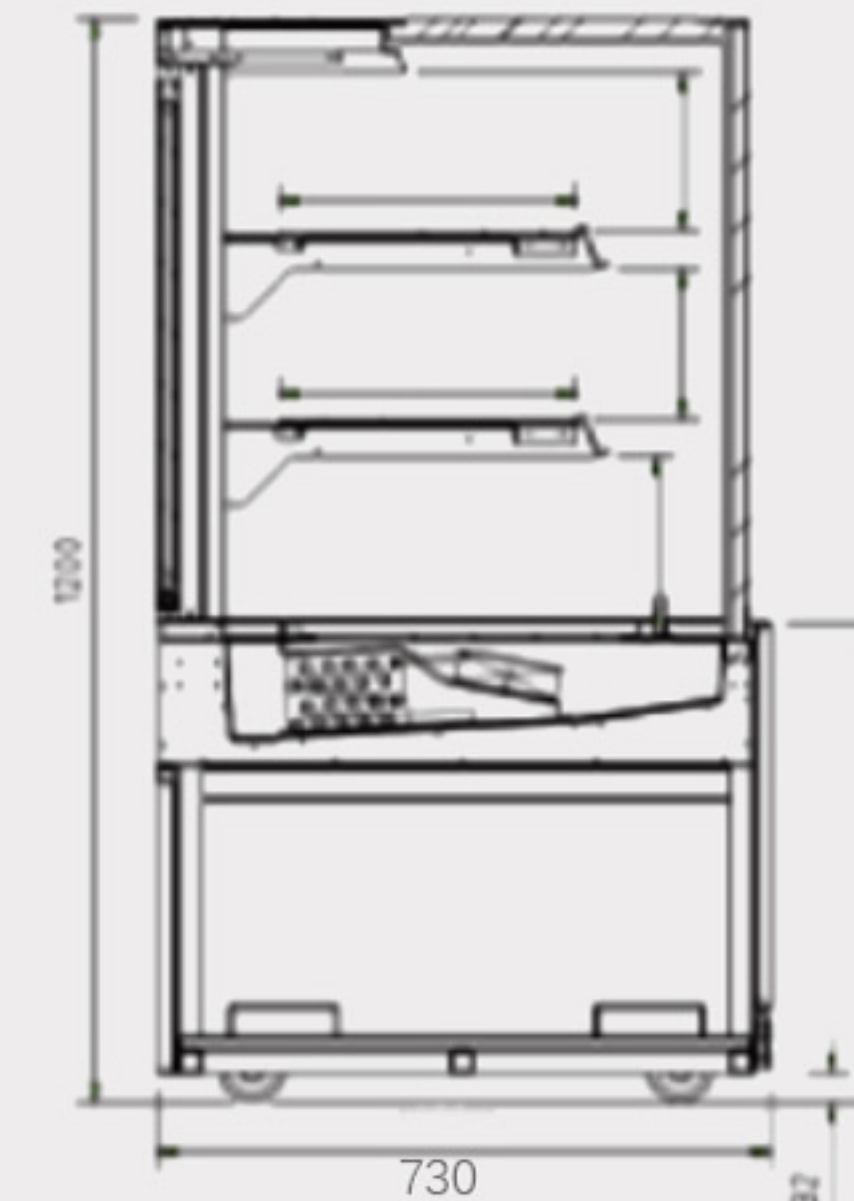
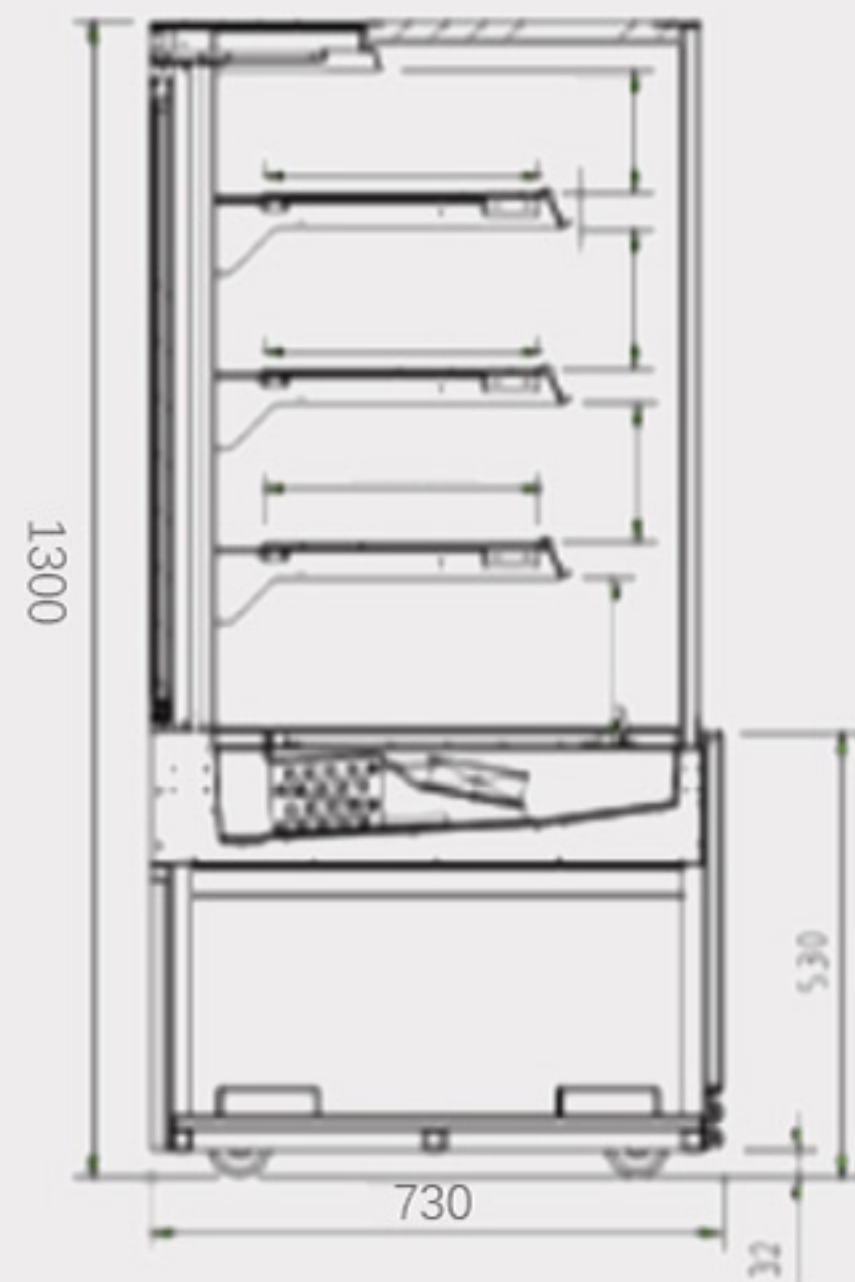



RD SERIES OF STRAIGHT GLASS FLOOR STANDING CABINETS



RD900S3



RD900S2



R290 refrigerant



#201 Stainless Steel Base



45° glass splicing



CUBIGEL Press



Pixie Temperature Control

Model No	Temp Range(°C)	Dimension(mm)	Capacity(L)	Shelves
RD900S3	2~8	900×730×1300	480	3
RD1000S3	2~8	1000×730×1300	535	3
RD1200S3	2~8	1200×730×1300	650	3
RD1500S3	2~8	1500×730×1300	815	3
RD1800S3	2~8	1800×730×1300	985	3
RD2000S3	2~8	2000×730×1300	1100	3

Model No	Temp Range(°C)	Dimension(mm)	Capacity(L)	Shelves
RD900S2	2~8	900×730×1200	380	2
RD1000S2	2~8	1000×730×1200	425	2
RD1200S2	2~8	1200×730×1200	515	2
RD1500S2	2~8	1500×730×1200	650	2
RD1800S2	2~8	1800×730×1200	785	2
RD2000S2	2~8	2000×730×1200	875	2

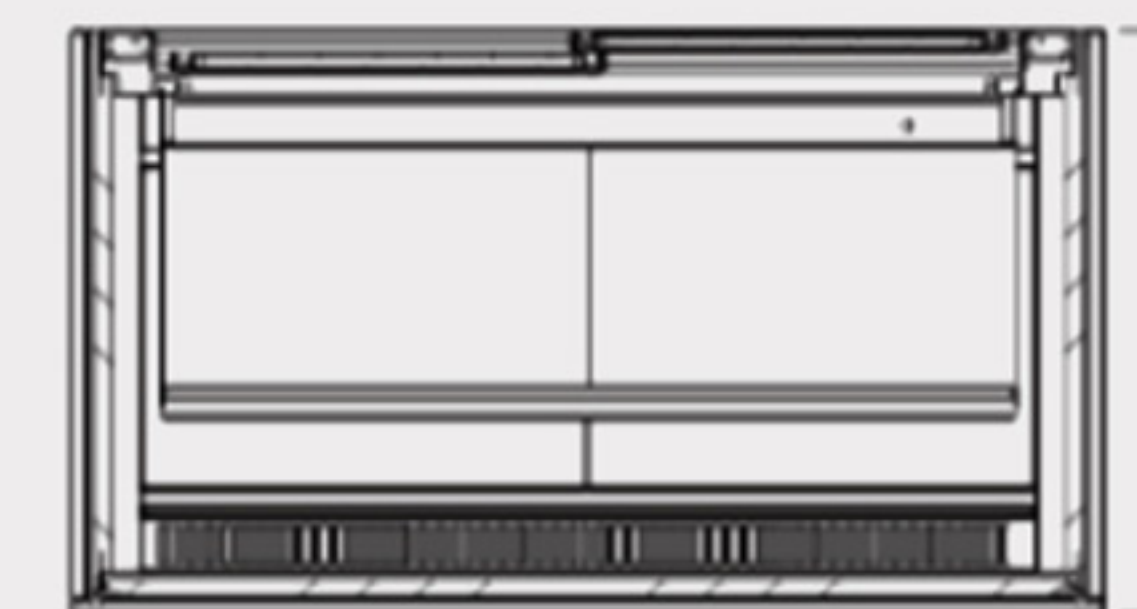
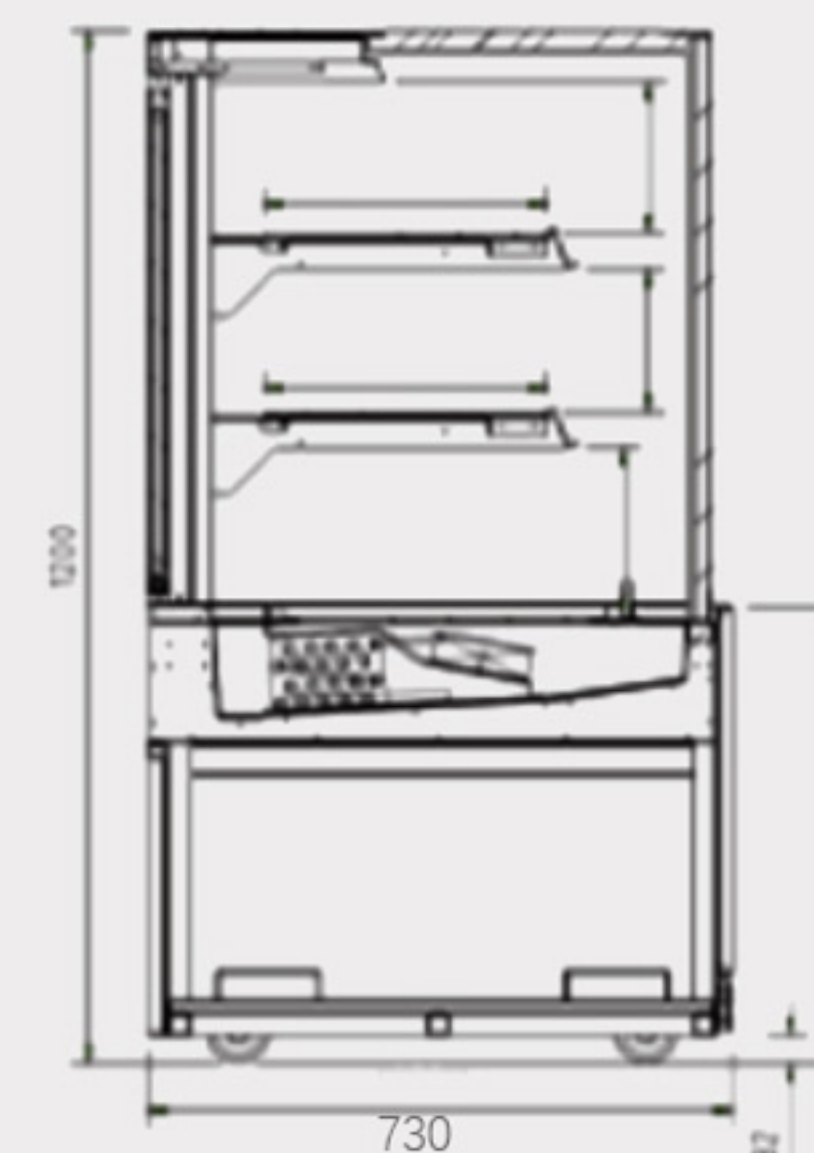
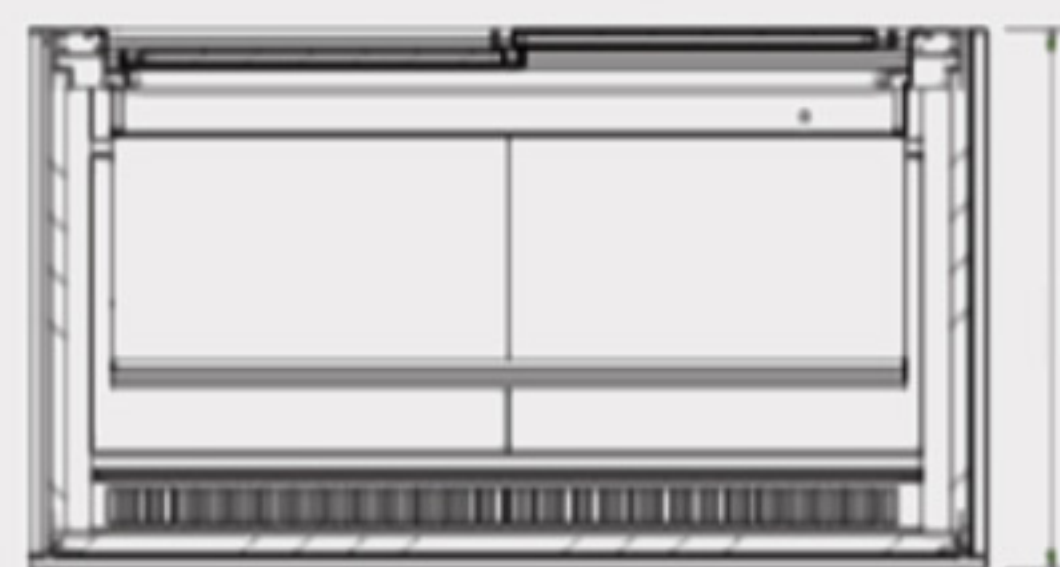



RE SERIES OF STRAIGHT GLASS

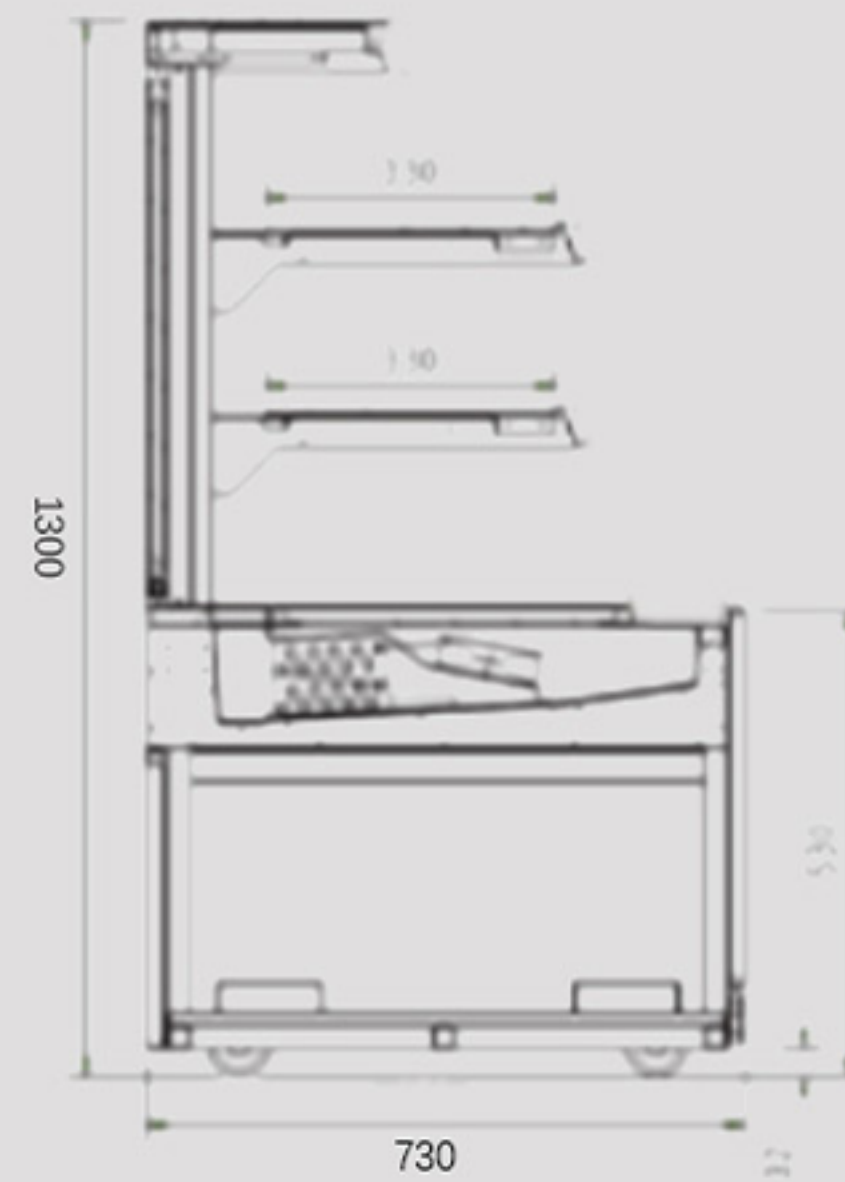

NW-900RX3

- #201 Stainless Steel Base
- CUBIGEL presses
- Pixie Temperature Control
- R290 refrigerant

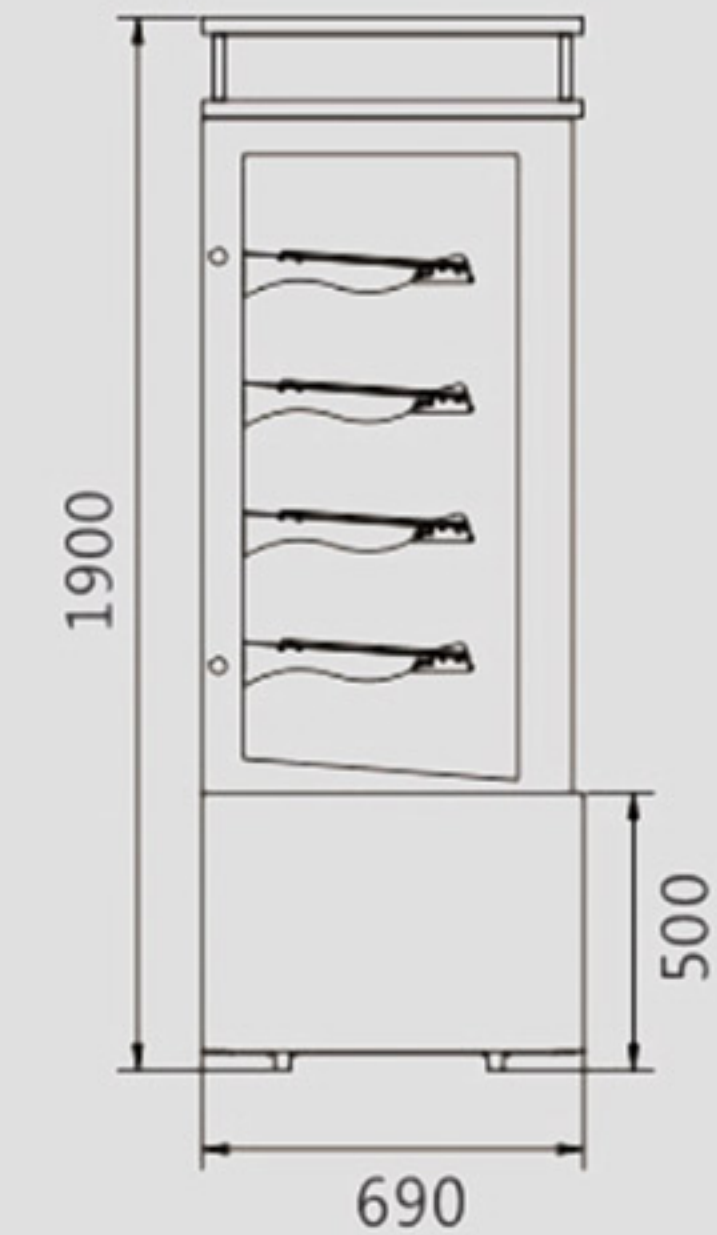

RE900S4

- #201 Stainless Steel Base
- CUBIGEL presses
- Pixie Temperature Control
- R290 refrigerant

Model No	Temp Range(°C)	Dimension(mm)	Capacity(L)	Shelves
NW-900RX3	2~8	900×730×1300	300	3
NW-100RX3	2~8	1000×730×1300	330	3
NW-1200RX3	2~8	1200×730×1300	400	3
NW-1500RX3	2~8	1500×730×1300	505	3
NW-1800RX3	2~8	1800×730×1300	610	3

Model No	Temp Range(°C)	Dimension(mm)	Capacity(L)	Shelves
RE900S4	2~8	900×690×1900	840	4
RE1200S4	2~8	1200×690×1900	1065	4
RE1500S4	2~8	1500×690×1900	1290	4
RE1800S4	2~8	1800×690×1900	1450	4
RE2100S4	2~8	2100×690×1900	1740	4

STRAIGHT GLASS TYPE

FLOOR STANDING CABINETS

>>>

Details and Benefits



01
Line Sense Landscaping



02
Condensate evaporation system

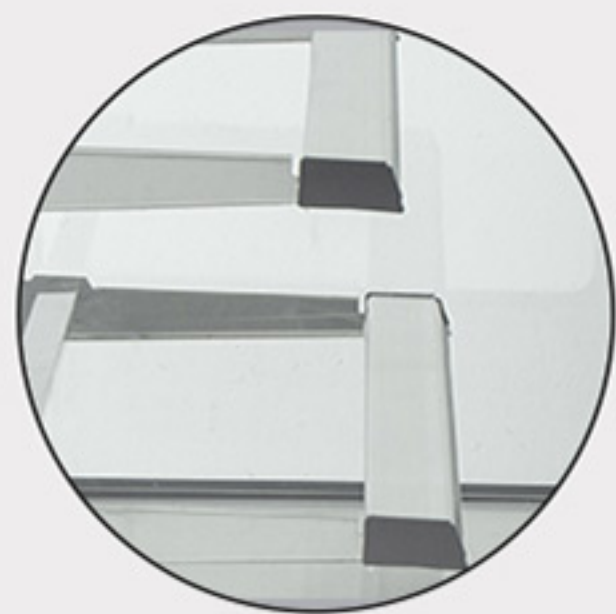

03
Stainless Steel Edged Shelf





CA SERIES OF CURVED GLASS FLOOR STANDING CABINETS



CA900S3



CA900S2



R290 refrigerant



#201 Stainless Steel Base



Includes heating wire



CUBIGEL Press



Pixie Temperature Control

Model No	Temp Range(°C)	Dimension(mm)	Capacity(L)	Shelves
CA900S3	2~8	900×730×1300	480	3
CA1000S3	2~8	1000×730×1300	535	3
CA1200S3	2~8	1200×730×1300	650	3
CA1500S3	2~8	1500×730×1300	815	3
CA1800S3	2~8	1800×730×1300	985	3
CA2000S3	2~8	2000×730×1300	1100	3

Model No	Temp Range(°C)	Dimension(mm)	Capacity(L)	Shelves
CA900S2	2~8	900×730×1200	380	2
CA1000S2	2~8	1000×730×1200	425	2
CA1200S2	2~8	1200×730×1200	515	2
CA1500S2	2~8	1500×730×1200	650	2
CA1800S2	2~8	1800×730×1200	785	2
CA2000S2	2~8	2000×730×1200	875	2

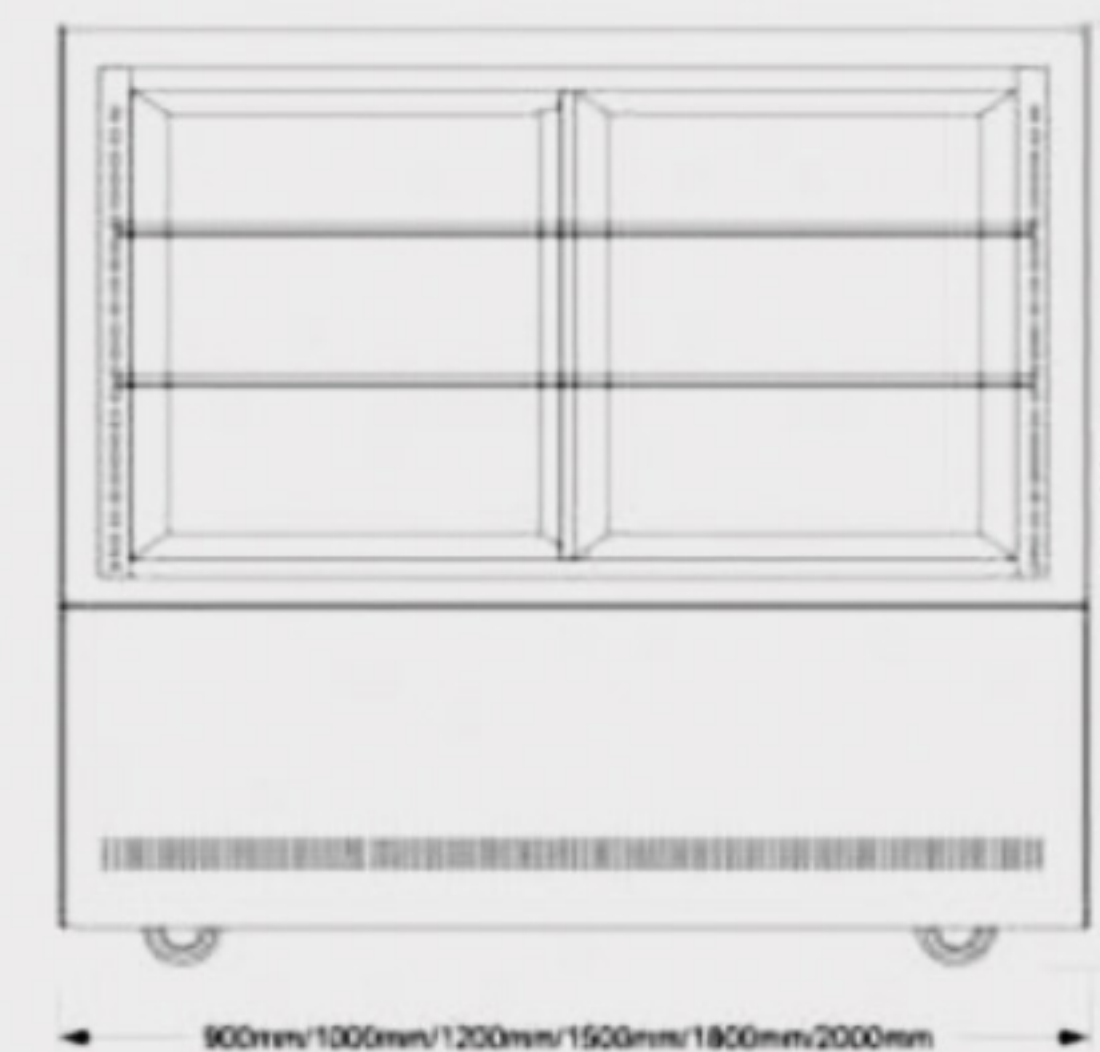
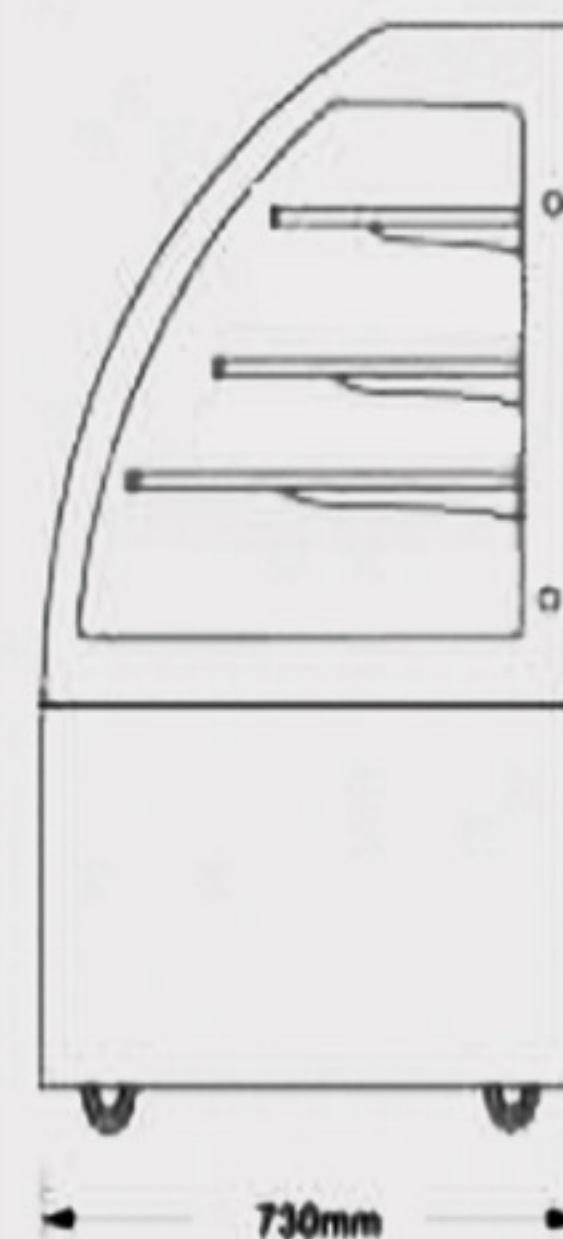
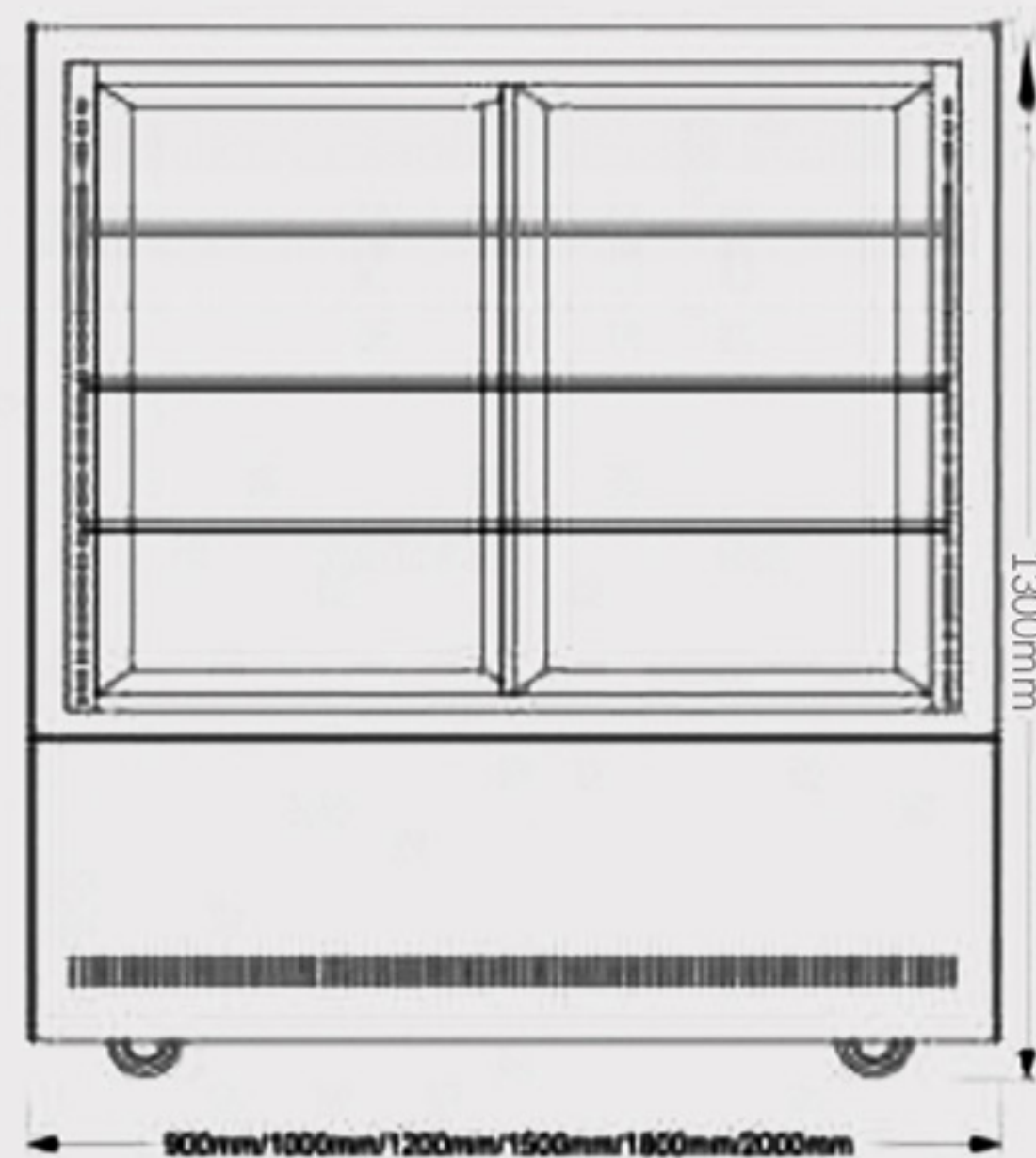



CB SERIES OF CURVED GLASS FLOOR STANDING CABINETS



CB900S3



CB900S2



R290 refrigerant



#201 Stainless Steel Base



Includes heating wire



CUBIGEL Press



Pixie Temperature Control

Model No	Temp Range(°C)	Dimension(mm)	Capacity(L)	Shelves
CB900S3	2~8	900×730×1300	480	3
CB1000S3	2~8	1000×730×1300	535	3
CB1200S3	2~8	1200×730×1300	650	3
CB1500S3	2~8	1500×730×1300	815	3
CB1800S3	2~8	1800×730×1300	985	3
CB2000S3	2~8	2000×730×1300	1100	3

Model No	Temp Range(°C)	Dimension(mm)	Capacity(L)	Shelves
CB900S2	2~8	900×730×1200	380	2
CB1000S2	2~8	1000×730×1200	425	2
CB1200S2	2~8	1200×730×1200	515	2
CB1500S2	2~8	1500×730×1200	650	2
CB1800S2	2~8	1800×730×1200	785	2
CB2000S2	2~8	2000×730×1200	875	2

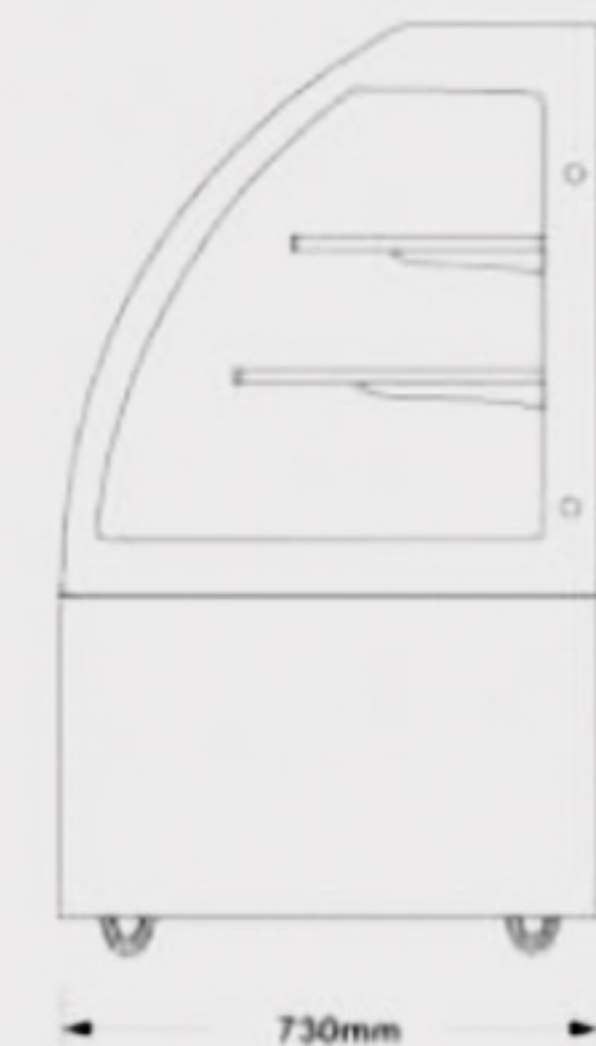
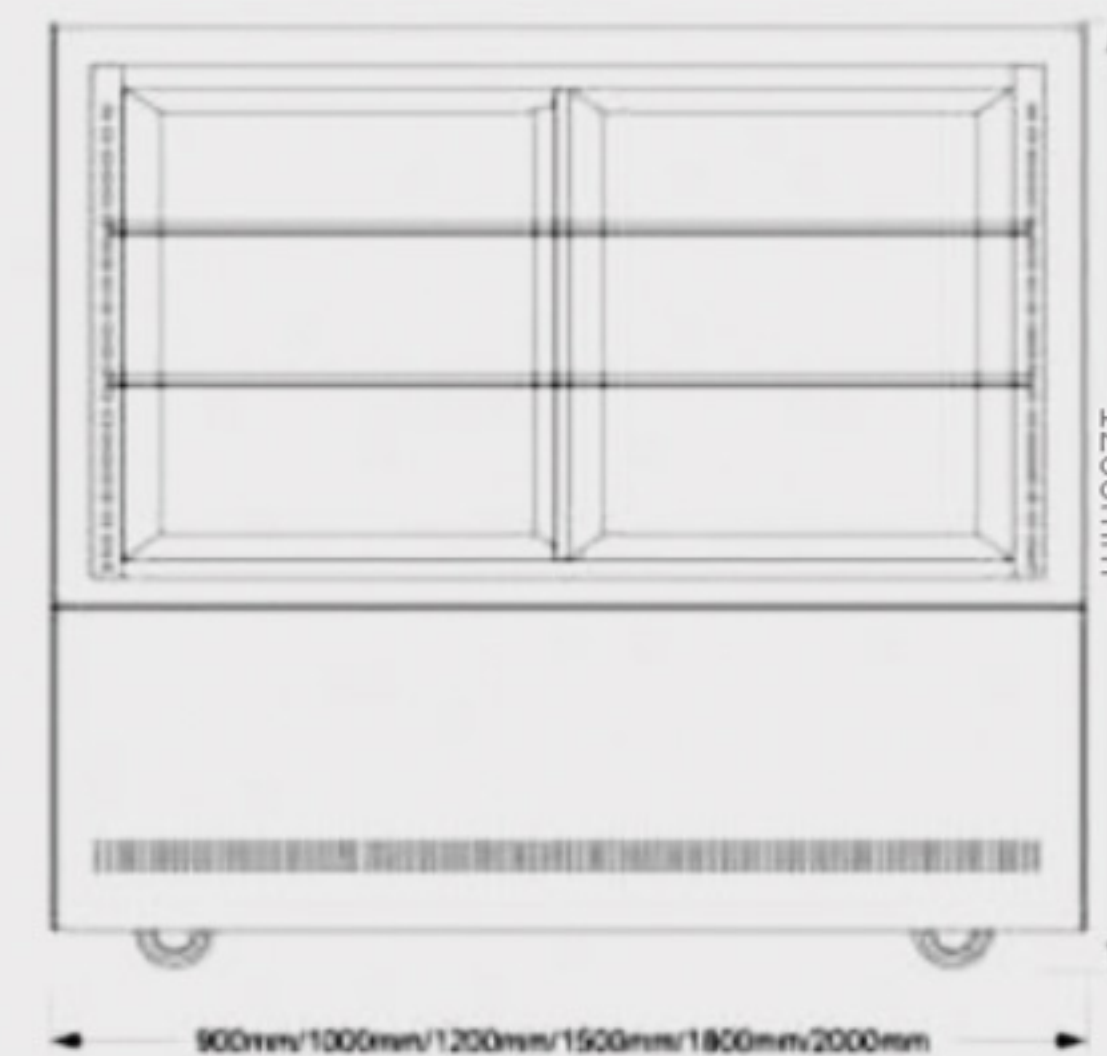
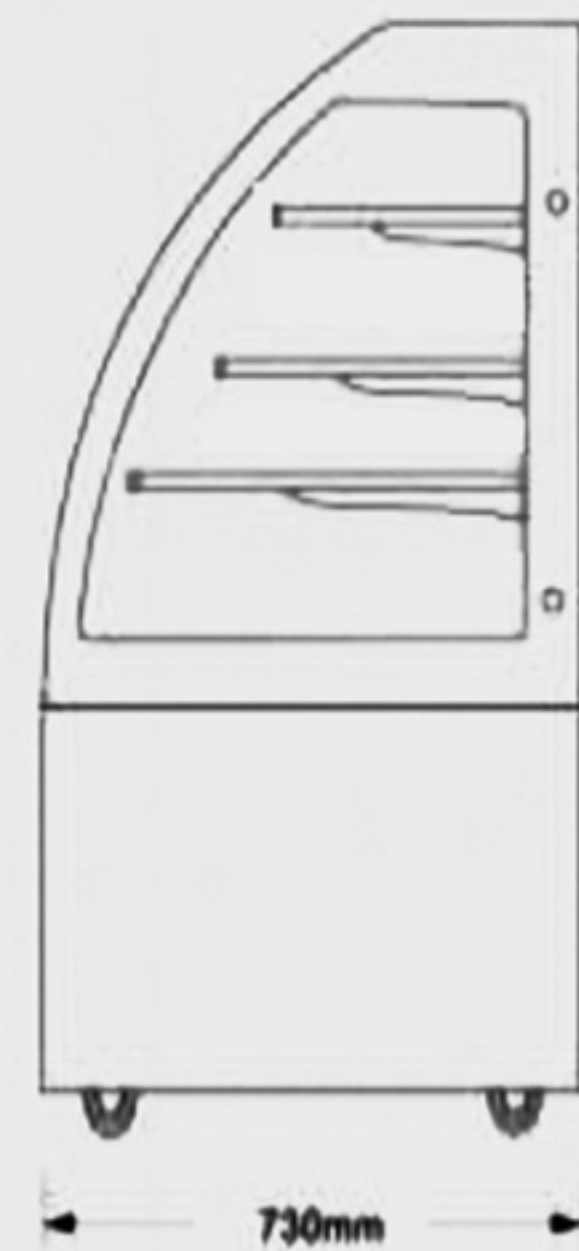
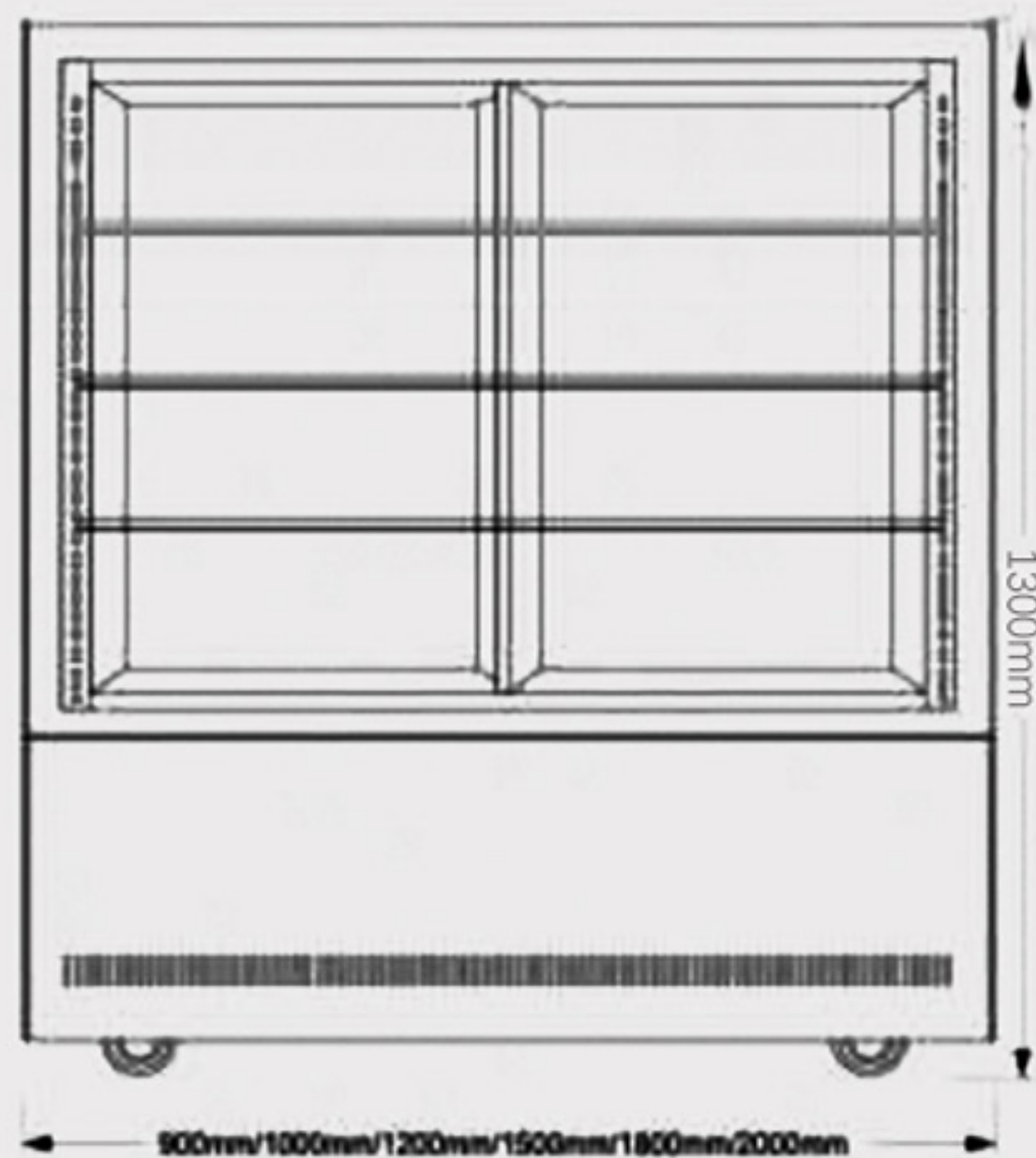



CC SERIES OF CURVED GLASS FLOOR STANDING CABINETS



CC900S3



CC900S2

-  R290 refrigerant
-  #201 Stainless Steel Base
-  Includes heating wire
-  CUBIGEL Press
-  Pixie Temperature Control

Model No	Temp Range(°C)	Dimension(mm)	Capacity(L)	Shelves
CC900S3	2~8	900×730×1300	480	3
CC1000S3	2~8	1000×730×1300	535	3
CC1200S3	2~8	1200×730×1300	650	3
CC1500S3	2~8	1500×730×1300	815	3
CC1800S3	2~8	1800×730×1300	985	3
CC2000S3	2~8	2000×730×1300	1100	3

Model No	Temp Range(°C)	Dimension(mm)	Capacity(L)	Shelves
CC900S2	2~8	900×730×1200	380	2
CC1000S2	2~8	1000×730×1200	425	2
CC1200S2	2~8	1200×730×1200	515	2
CC1500S2	2~8	1500×730×1200	650	2
CC1800S2	2~8	1800×730×1200	785	2
CC2000S2	2~8	2000×730×1200	875	2

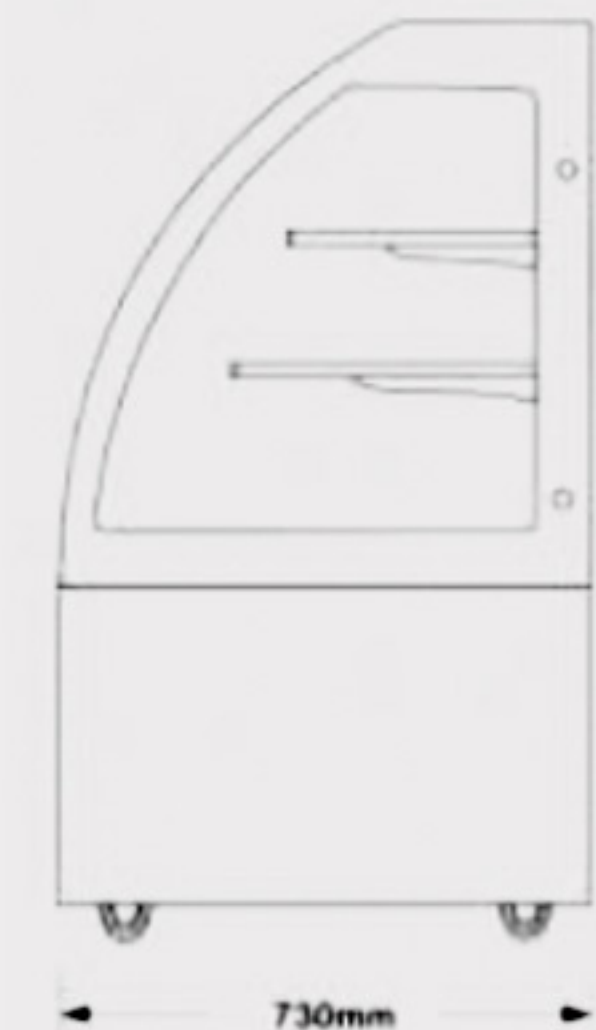
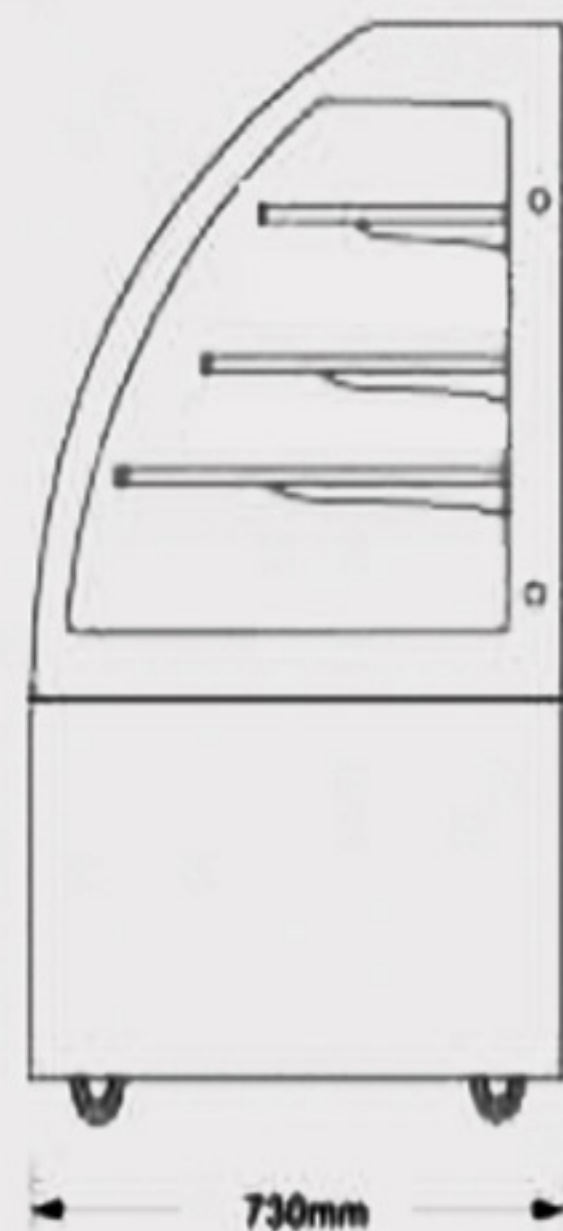
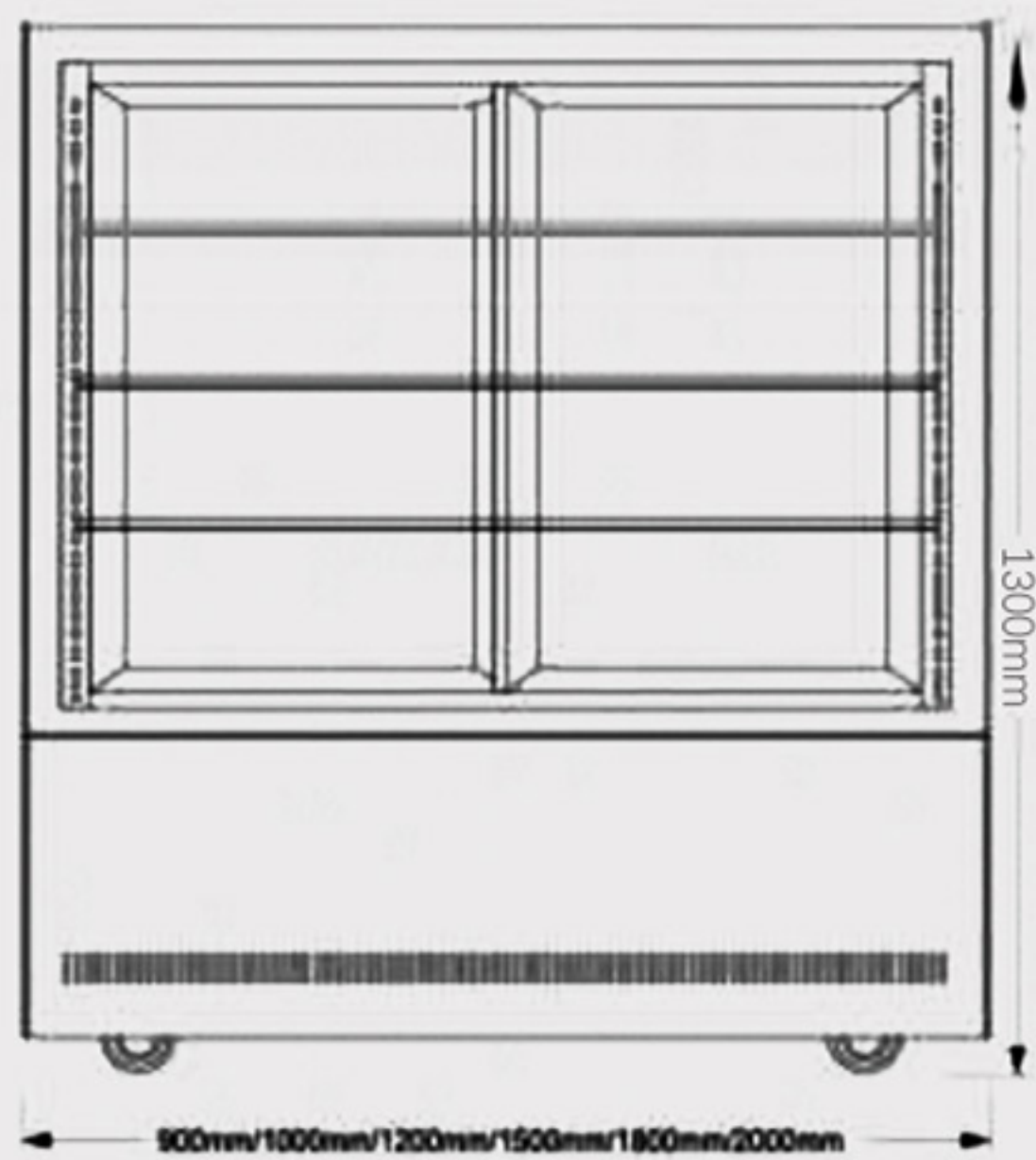



CD SERIES OF CURVED GLASS FLOOR STANDING CABINETS



CD900S3



CD900S2



R290 refrigerant



#201 Stainless Steel Base



Includes heating wire



CUBIGEL Press



Pixie Temperature Control

Model No	Temp Range(°C)	Dimension(mm)	Capacity(L)	Shelves
CD900S3	2-8	900×680×1380	480	3
CD1200S3	2-8	1200×680×1380	535	3
CD1500S3	2-8	1500×680×1380	650	3
CD1800S3	2-8	1800×680×1380	815	3
CD2100S3	2-8	2100×680×1380	985	3

Model No	Temp Range(°C)	Dimension(mm)	Capacity(L)	Shelves
CD900S2	2-8	900×680×1200	482	2
CD1200S2	2-8	1200×680×1200	518	2
CD1500S2	2-8	1500×680×1200	666	2
CD1800S2	2-8	1800×680×1200	814	2
CD2100S2	2-8	2100×730×1200	962	2

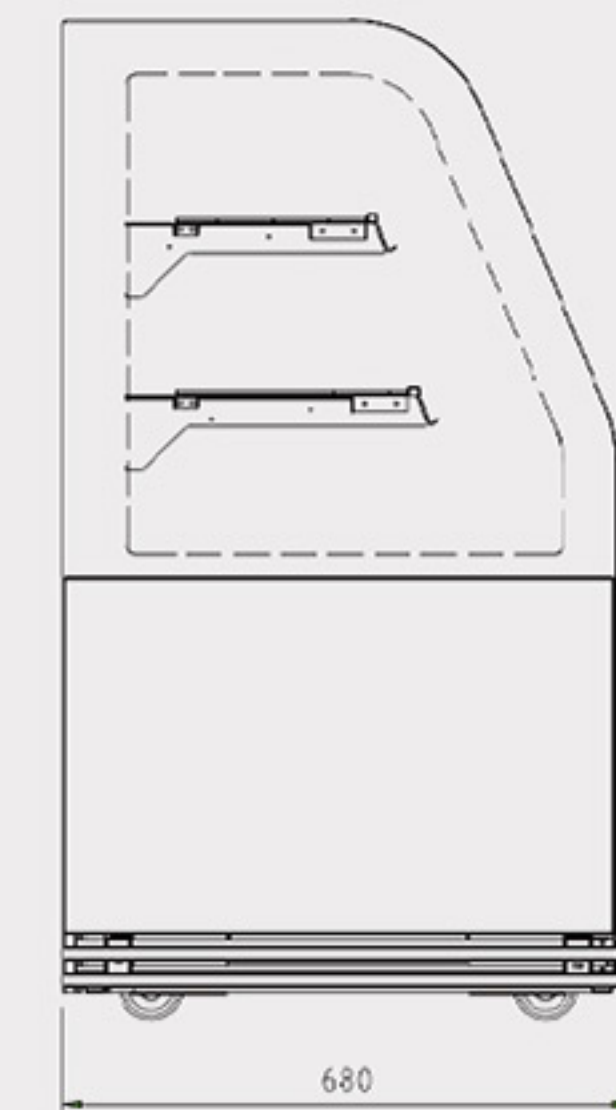
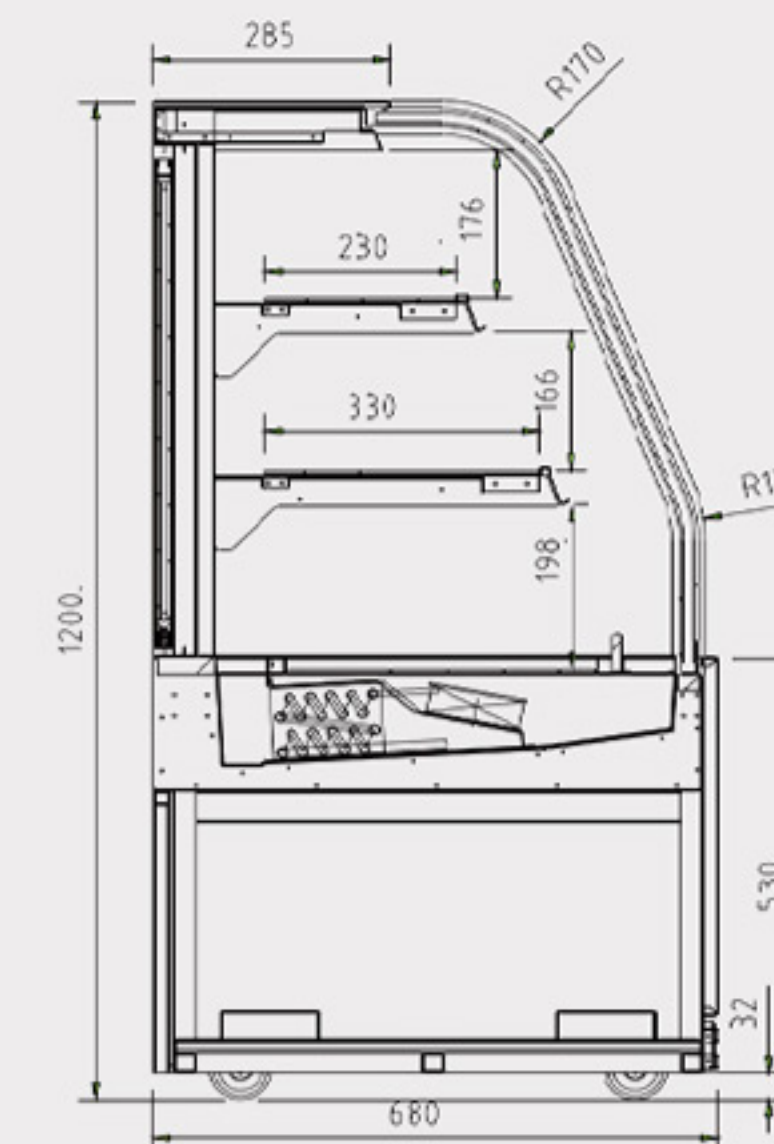
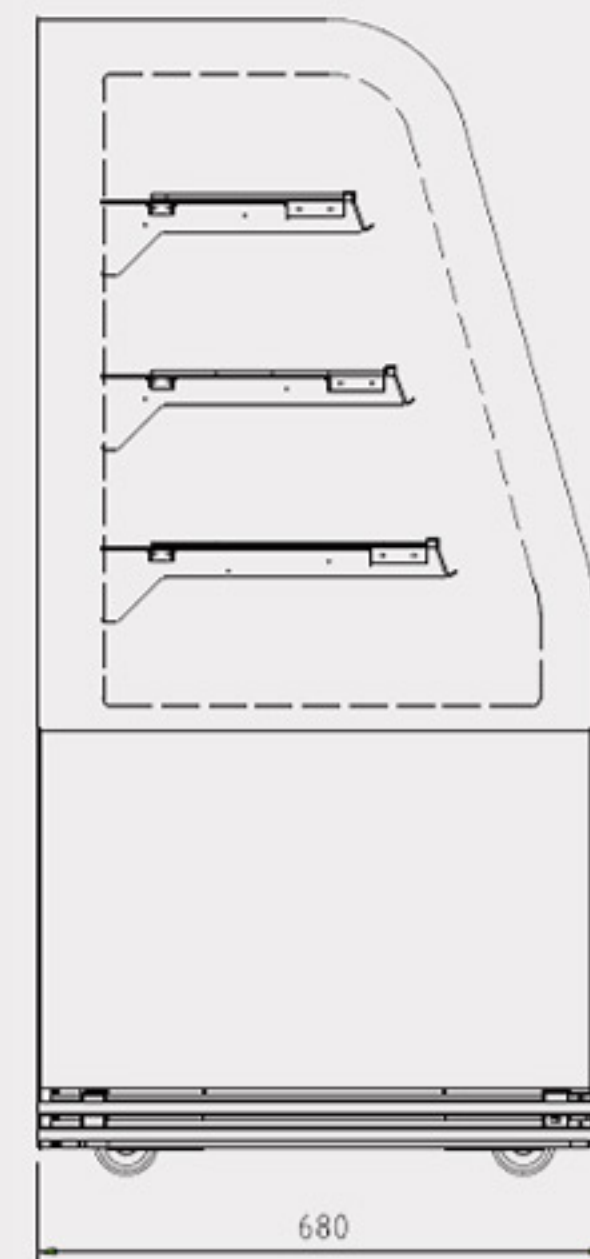
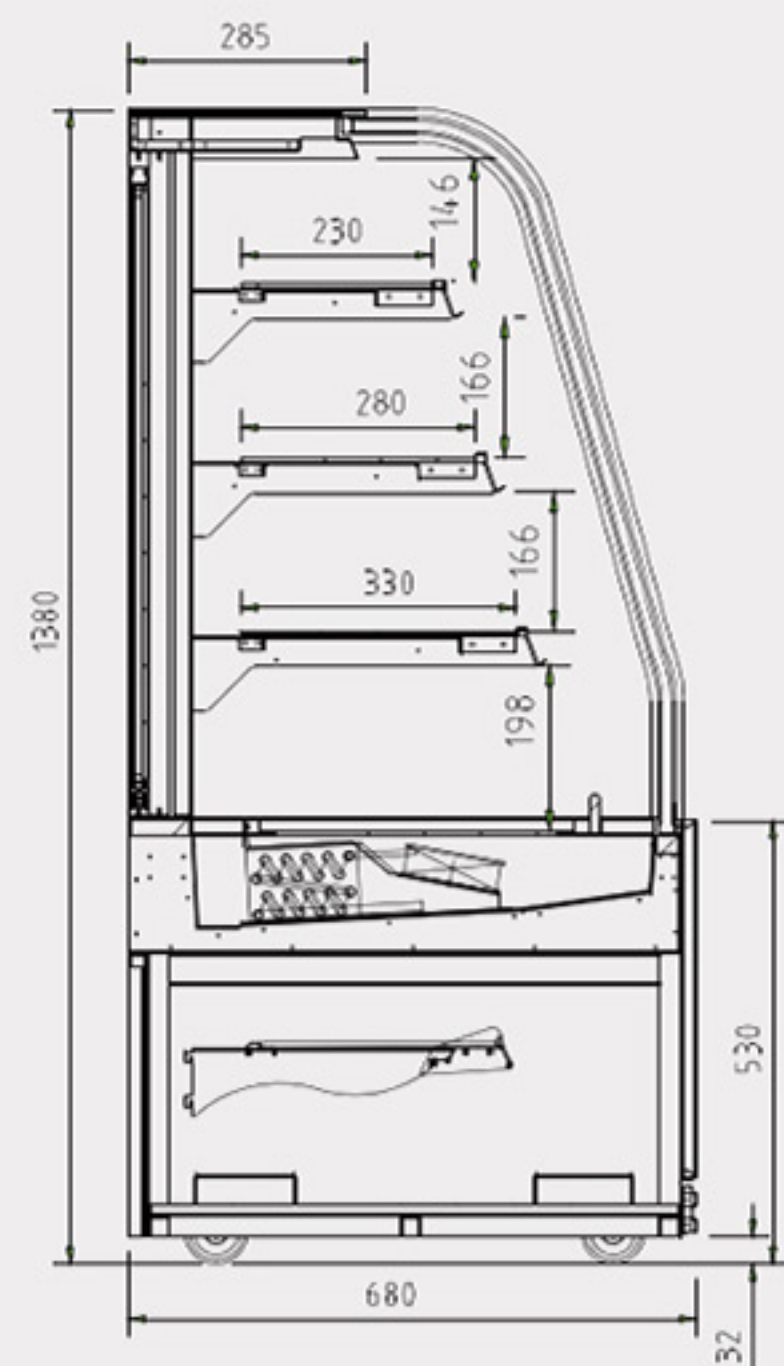

FRONT OPEN TYPE FLOOR STANDING CABINETS

>>>

Details and Benefits



01
Line Sense Landscaping



02
Condensate evaporation system

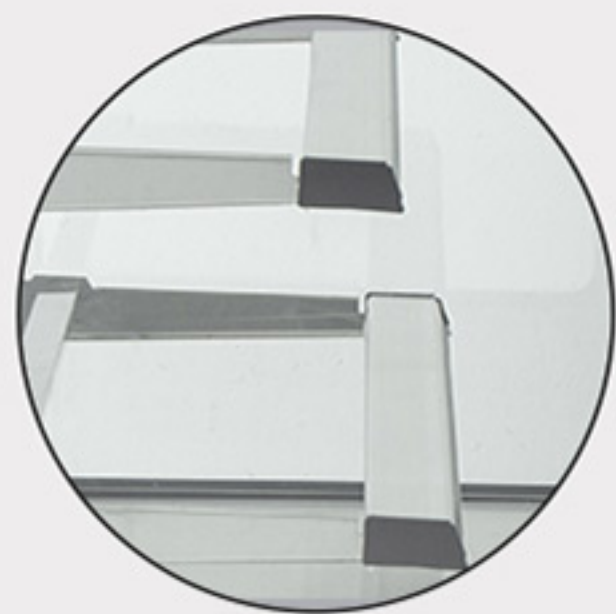

03
Stainless Steel Edged Shelf





FA SERIES OF FRONT OPEN FLOOR STANDING CABINETS



FA900S2



FA900S3

-  R290 refrigerant
-  #201 Stainless Steel Base
-  Tempered heating film
-  CUBIGEL Press
-  Pixie Temperature Control

Model No	Temp Range(°C)	Dimension(mm)	Capacity(L)	Shelves
FA1200S3	2-8	1200×730×1370	470	3
FA1500S3	2-8	1500×730×1370	620	3
FA1800S3	2-8	1800×730×1370	720	3
FA2000S3	2-8	2100×730×1370	895	3
FA2400S3	2-8	2400×730×1370	1070	3

Model No	Temp Range(°C)	Dimension(mm)	Capacity(L)	Shelves
FA1200S2	2-8	1200×730×1200	536	2
FA1500S2	2-8	1500×730×1200	593	2
FA1800S2	2-8	1800×730×1200	743	2
FA2000S2	2-8	2100×730×1200	894	2
FA2400S2	2-8	2400×730×1200	1043	2

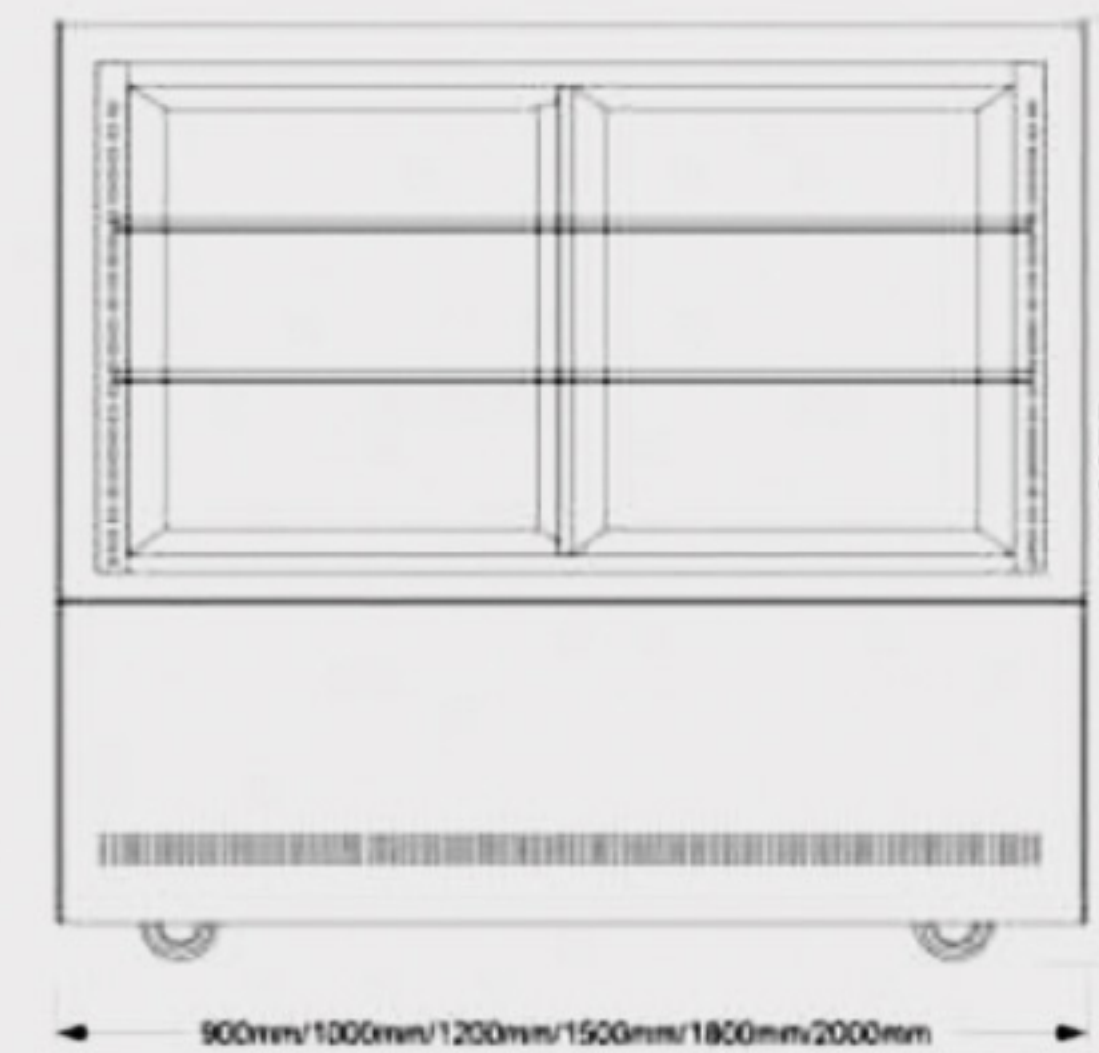
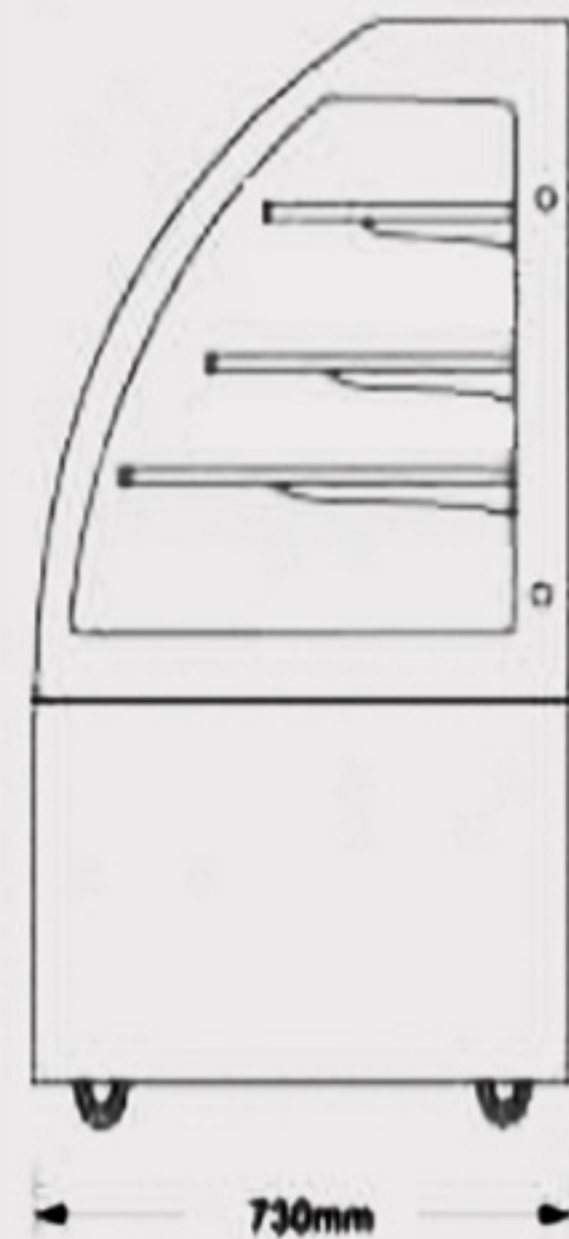
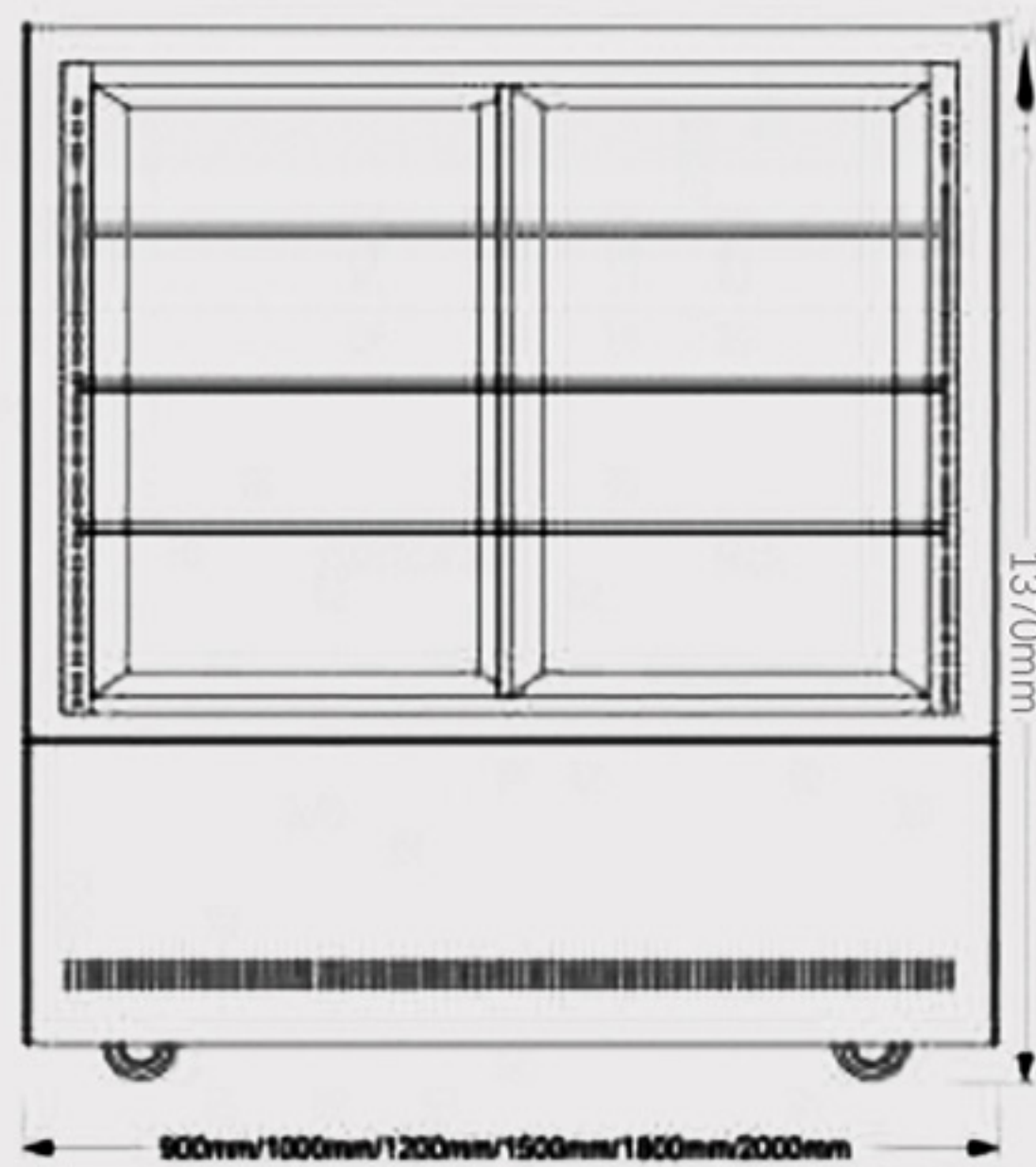



FB SERIES OF FRONT OPEN FLOOR STANDING CABINETS

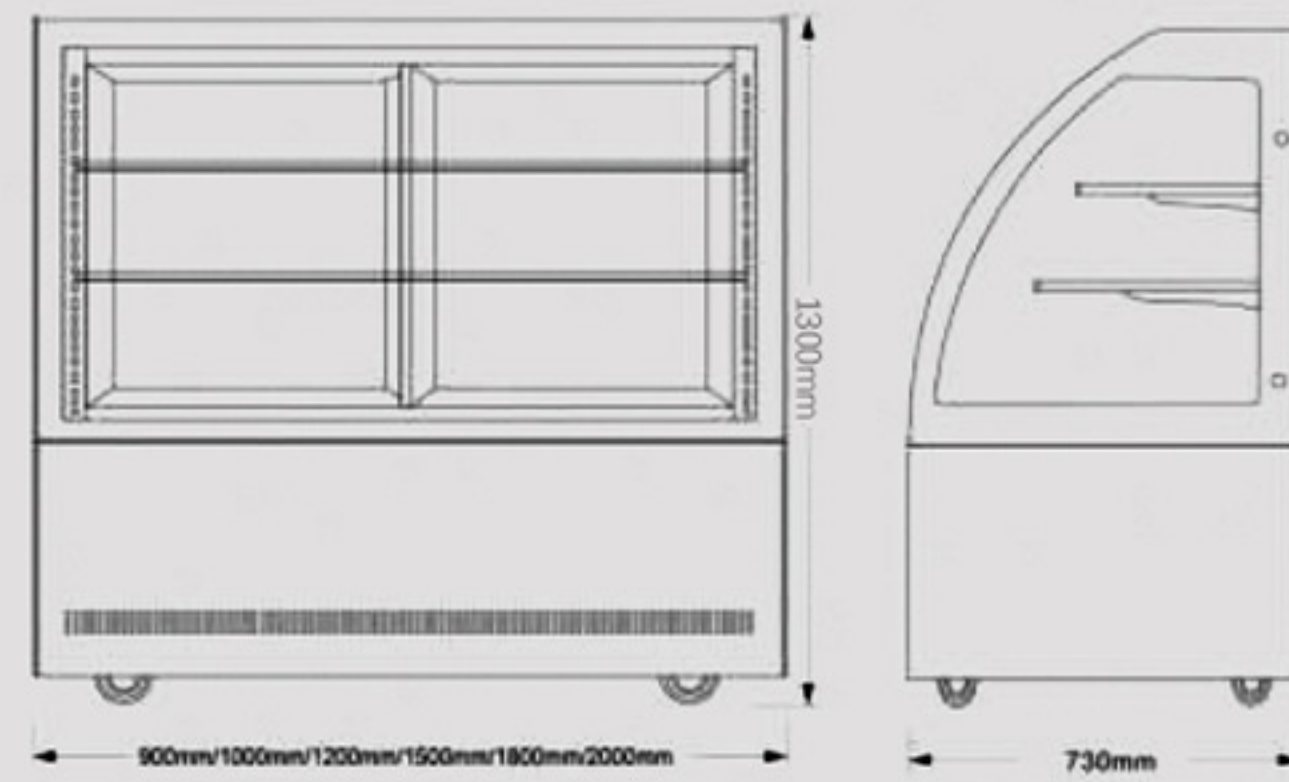

FB900S2

- #201 Stainless Steel Base
- CUBIGEL presses
- Pixie Temperature Control
- R290 refrigerant

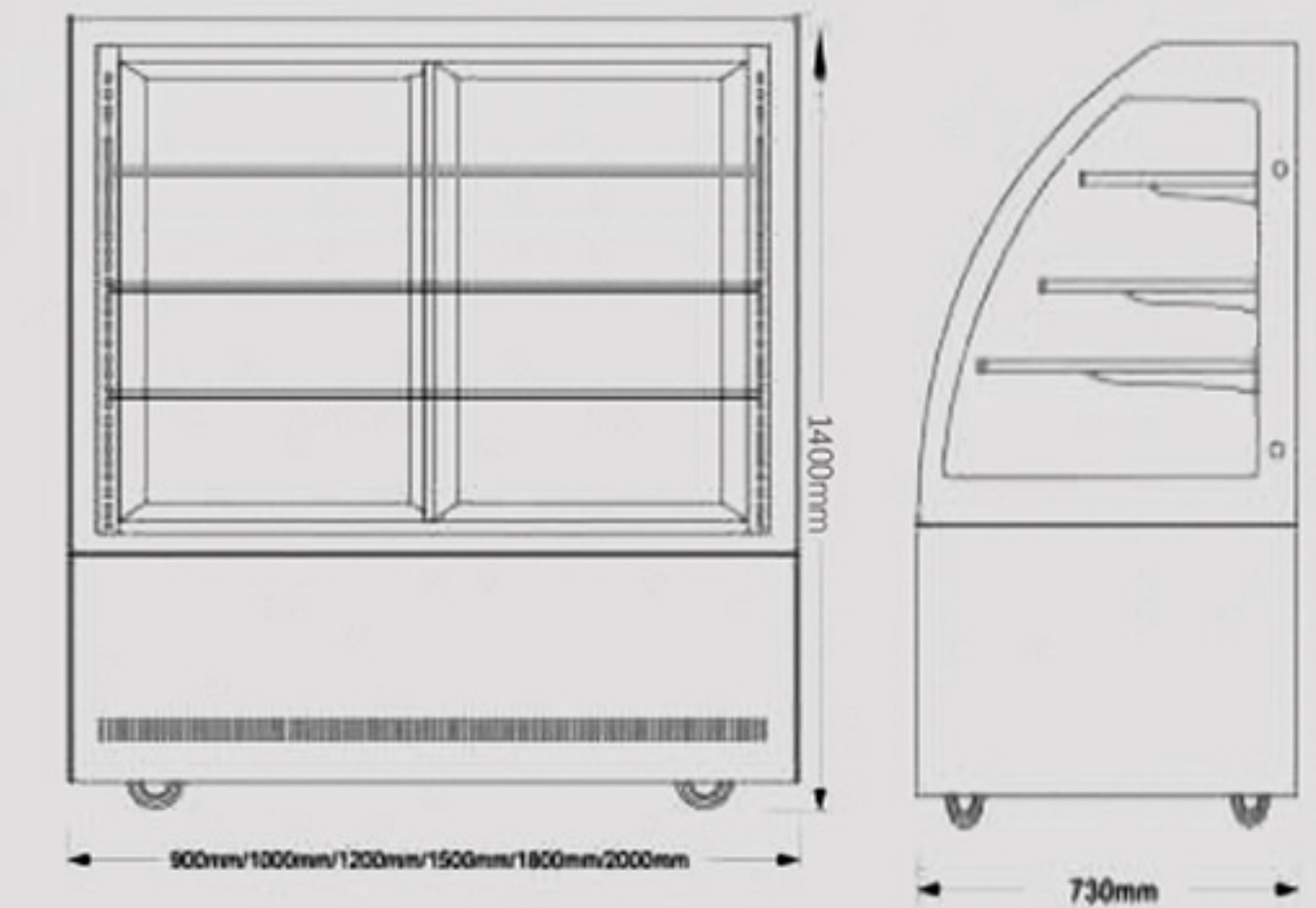

FB1200S3

- #201 Stainless Steel Base
- CUBIGEL presses
- Pixie Temperature Control
- R290 refrigerant

Model No	Temp Range(°C)	Dimension(mm)	Capacity(L)	Shelves
FB900S2	2~8	900×730×1300	314	2
FB1200S2	2~8	1200×730×1300	464	2
FB1500S2	2~8	1500×730×1300	614	2
FB1800S2	2~8	1800×730×1300	764	2

Model No	Temp Range(°C)	Dimension(mm)	Capacity(L)	Shelves
FB1200S3	2~8	1200×710×1400	400	3
FB1500S3	2~8	1500×710×1400	505	3
FB1800S3	2~8	1800×710×1400	650	3
FB2000S3	2~8	2000×710×1400	750	3

ARCH GLASS TYPE

FLOOR STANDING CABINETS

>>>

Details and Benefits

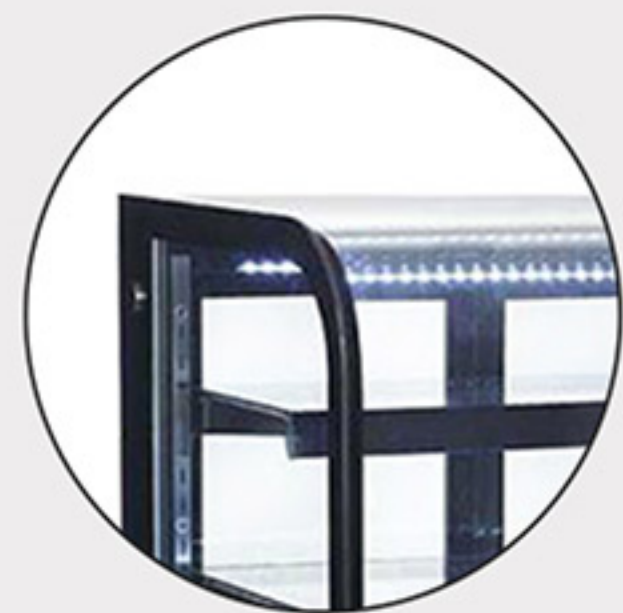

01
Line Sense Landscaping



02
Condensate evaporation system



03
Stainless Steel Edged Shelf





AA SERIES OF ARCH GLASS FLOOR STANDING CABINETS



AA900S3



AA900S2



R290 refrigerant



#201 Stainless Steel Base



With heater



CUBIGEL Press



Digital Controller

Model No	Temp Range(°C)	Dimension(mm)	Capacity(L)	Shelves
AA900S3	2~8	900*675*1215	80	3
AA1200S3	2~8	1200*675*1215	535	3
AA1500S3	2~8	1500*675*1215	650	3
AA1800S3	2~8	1790*675*1215	815	3

Model No	Temp Range(°C)	Dimension(mm)	Capacity(L)	Shelves
AA900S2	2~8	915*675*1215	320	2
AA1200S2	2~8	1215*675*1215	440	2
AA1500S2	2~8	1515*675*1215	550	2

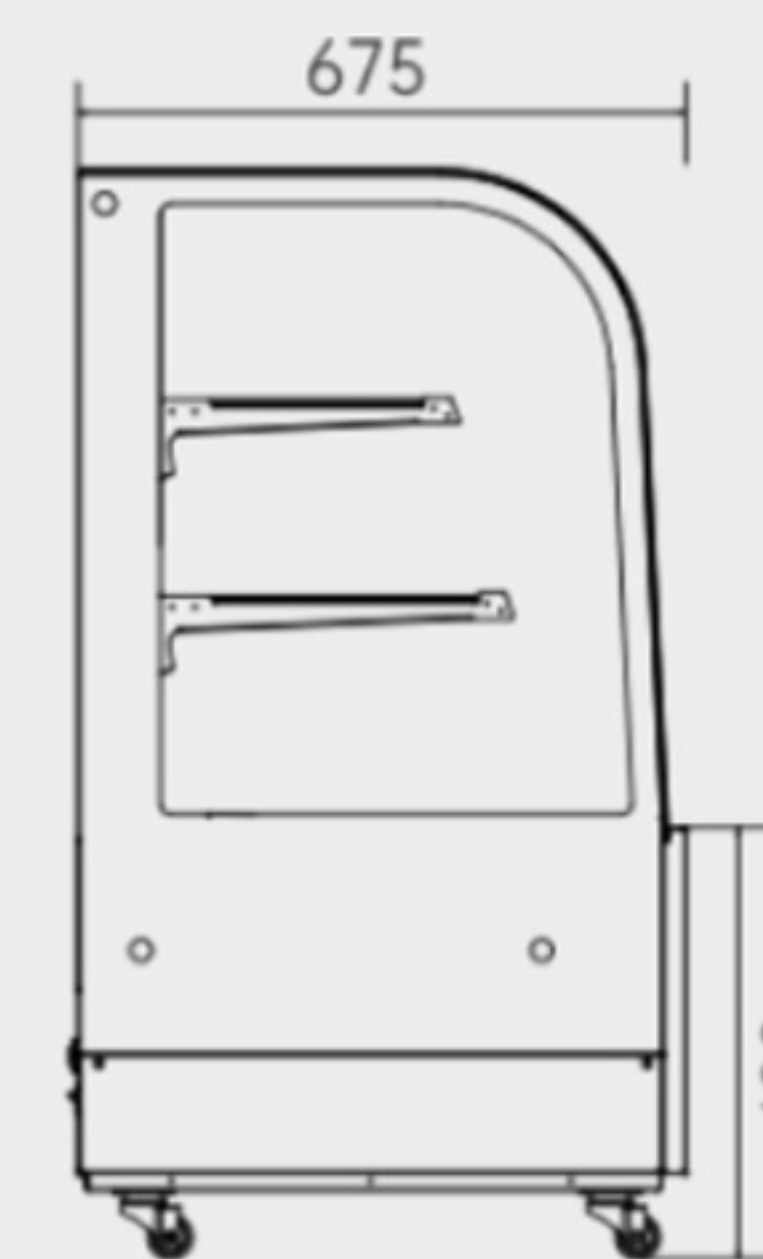
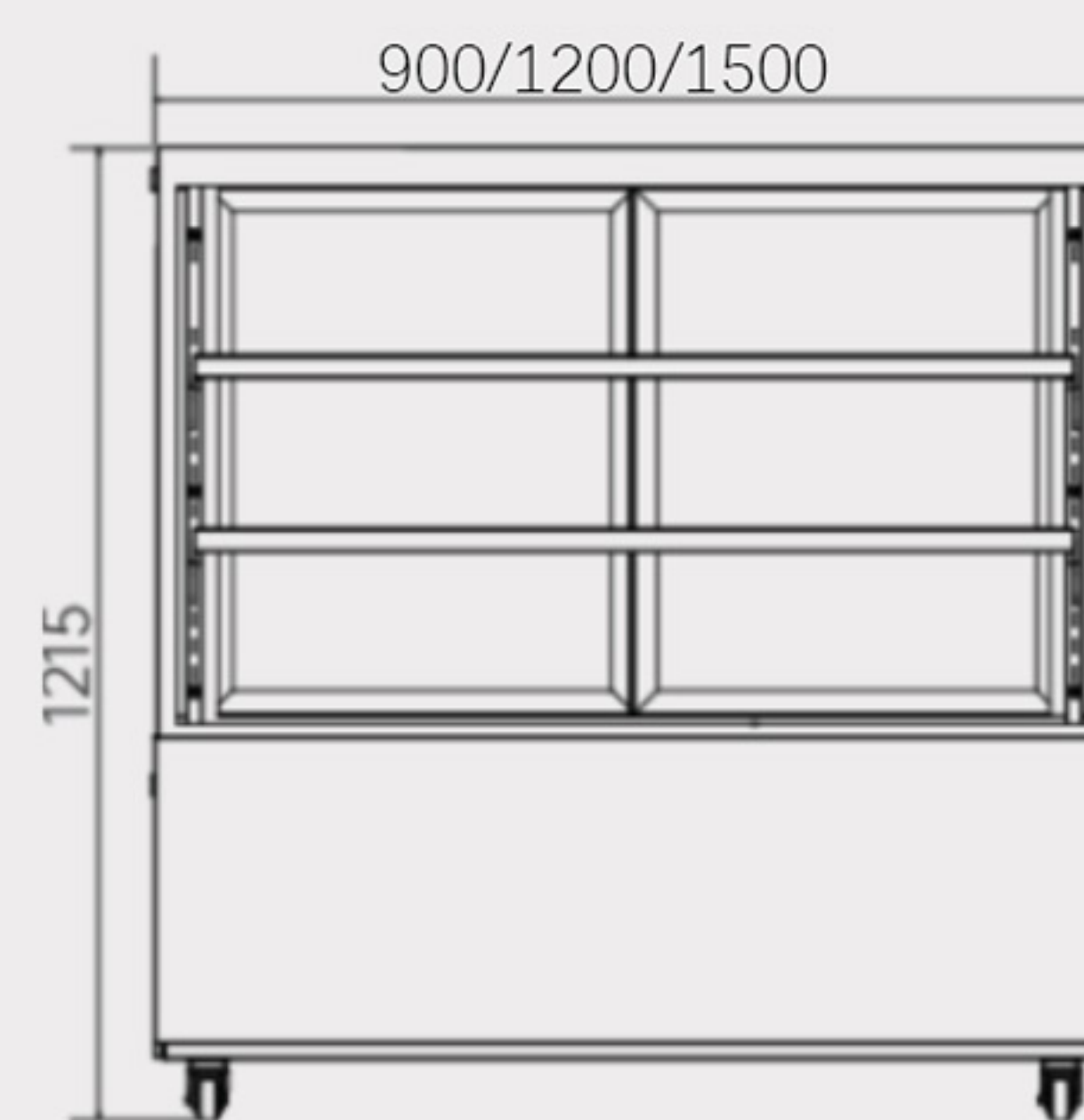
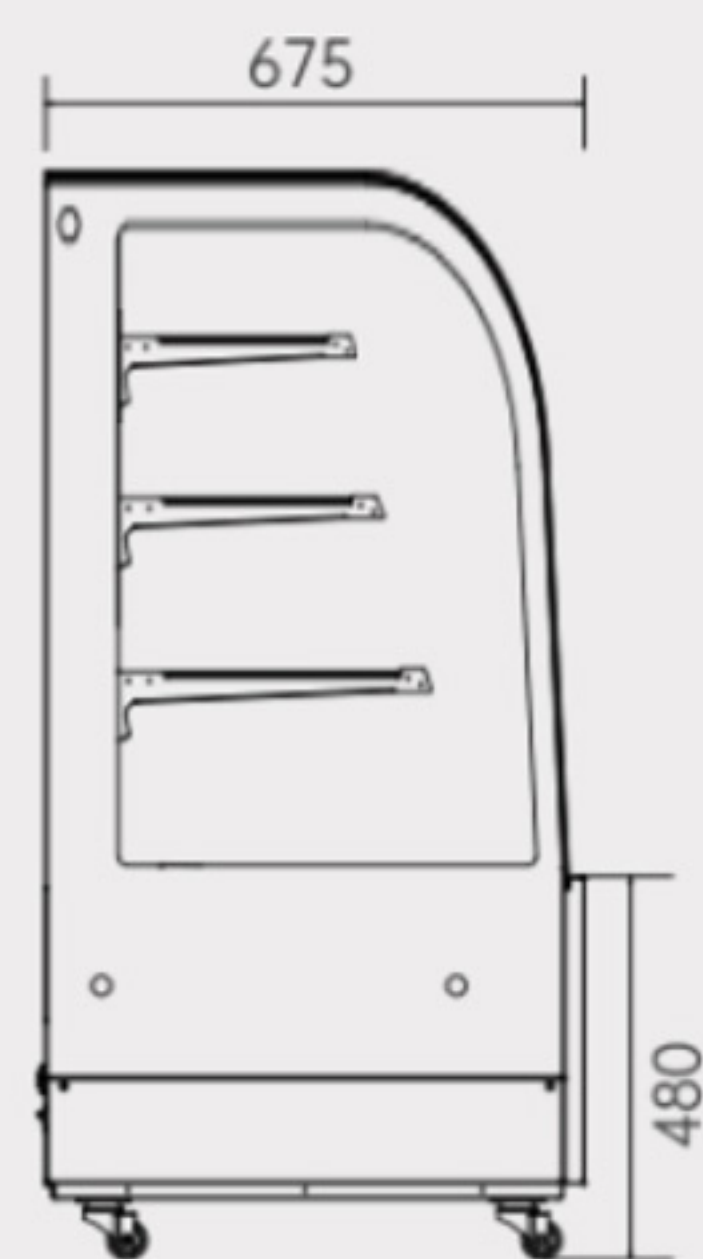
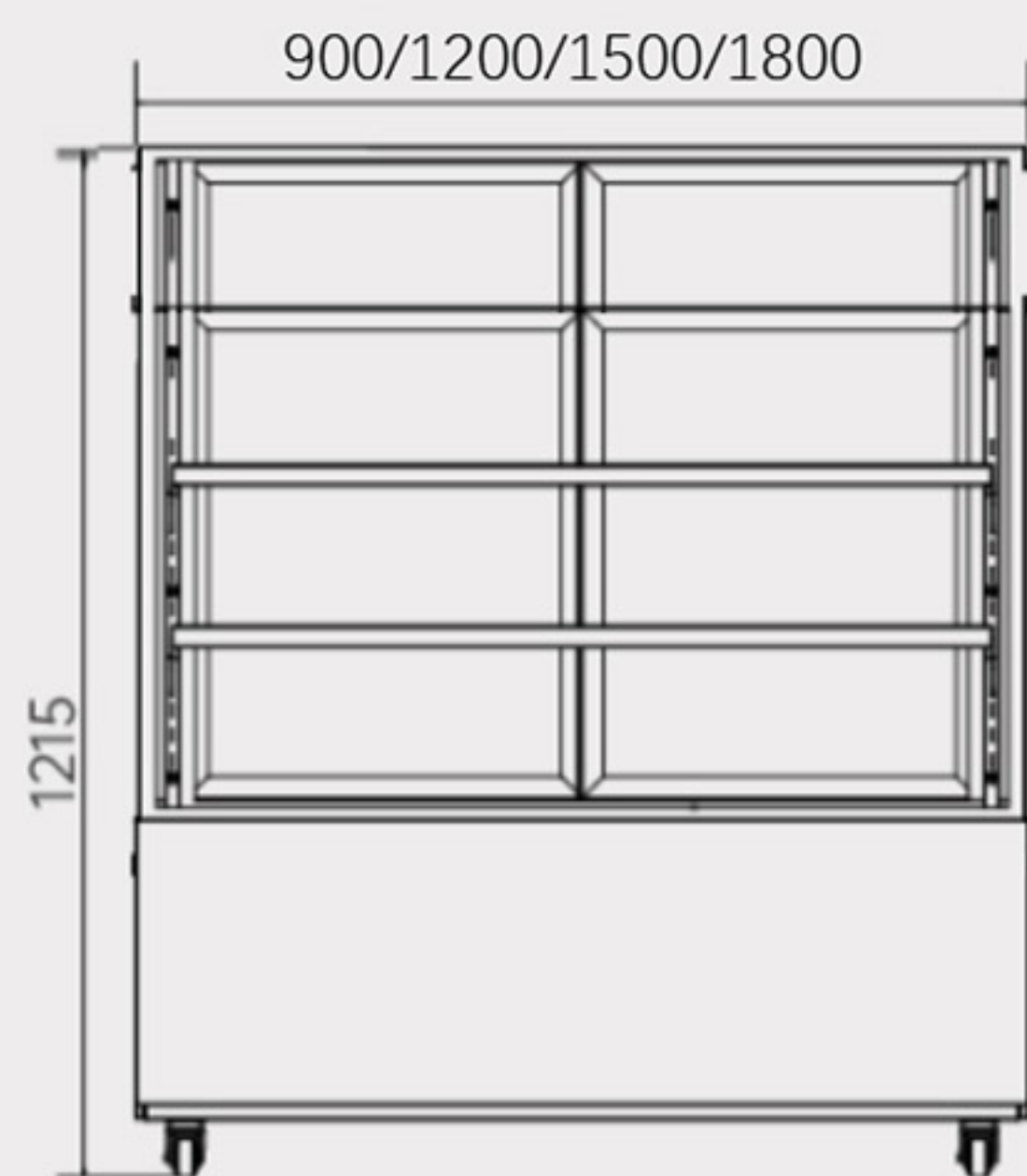

CORNER SECTOR TYPE

FLOOR STANDING CABINETS

>>>

Details and Benefits

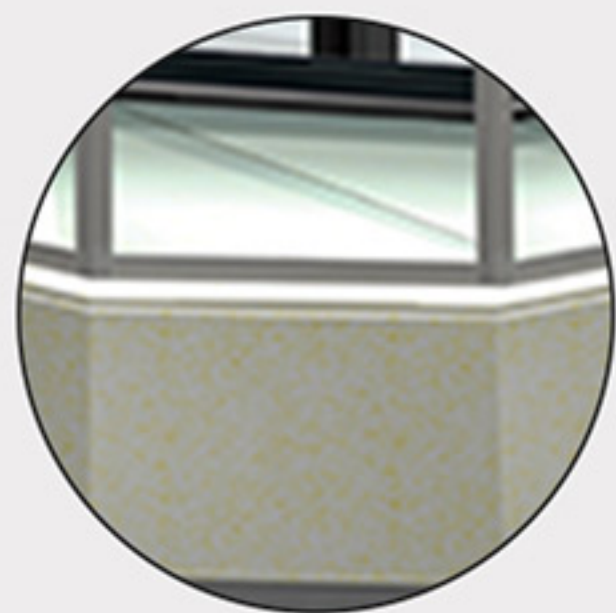

01
Line Sense Landscaping



02
Condensate evaporation system



03
Stainless Steel Edged Shelf

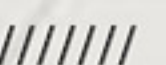



CA SERIES OF CORNER SECTOR GLASS FLOOR STANDING CABINETS



NW-CCK670 (2100×800×1300)



R290 refrigerant



#201 Stainless Steel Base



With heater



CUBIGEL Press



Digital Controller

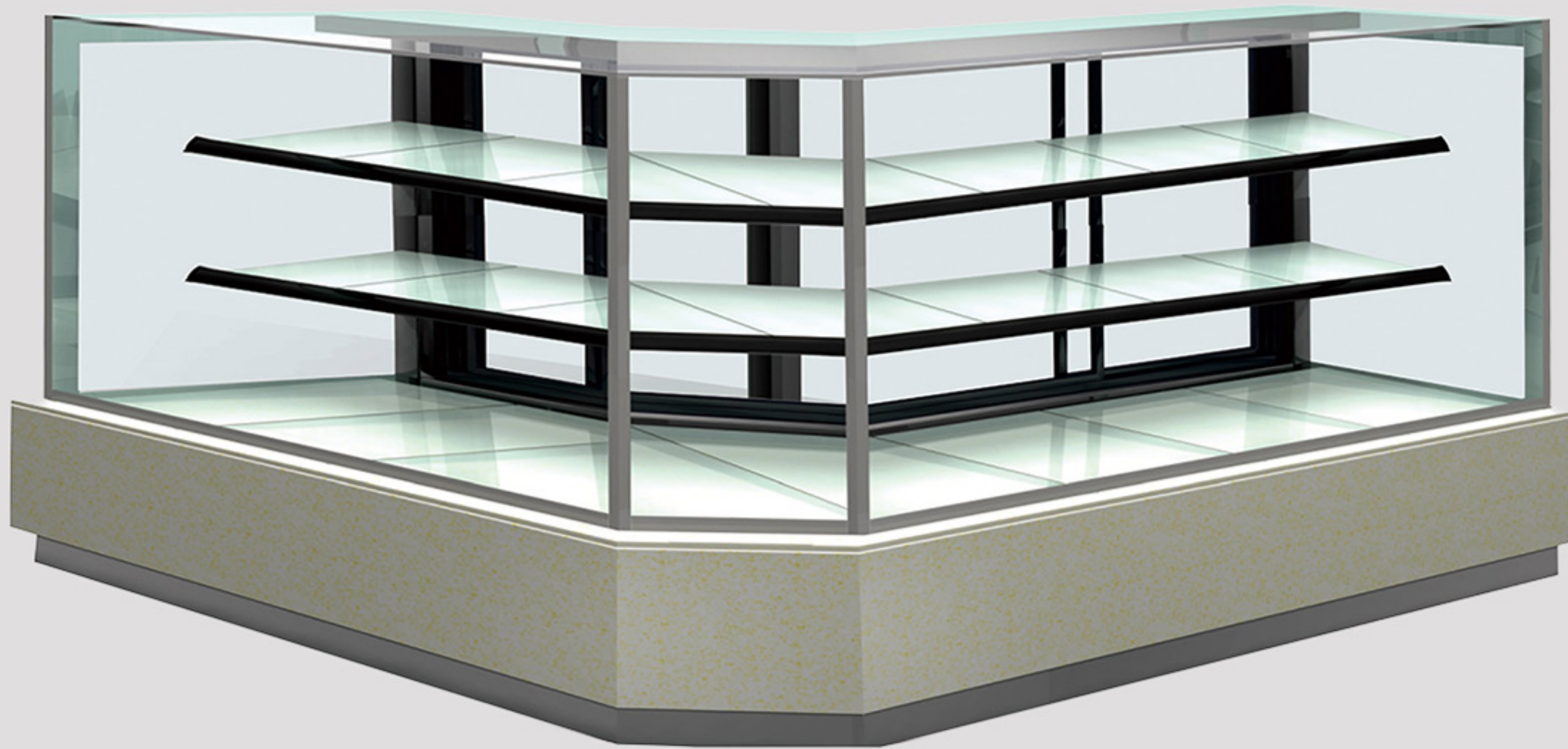

CA1500S2

Model No	Temp Range(°C)	Dimension(mm)	Shelves
CA1500S2	2-8	1500+1500x675x1210	3
CA1800S2	2-8	1800+1800x675x1210	3
CA2100S2	2-8	2100+2100x675x1210	3
CA2400S2	2-8	2400+2400x675x1210	3

Customization Optional

